

Serie CREMAGLIERE AD INCASSO

EMBEDDED Series

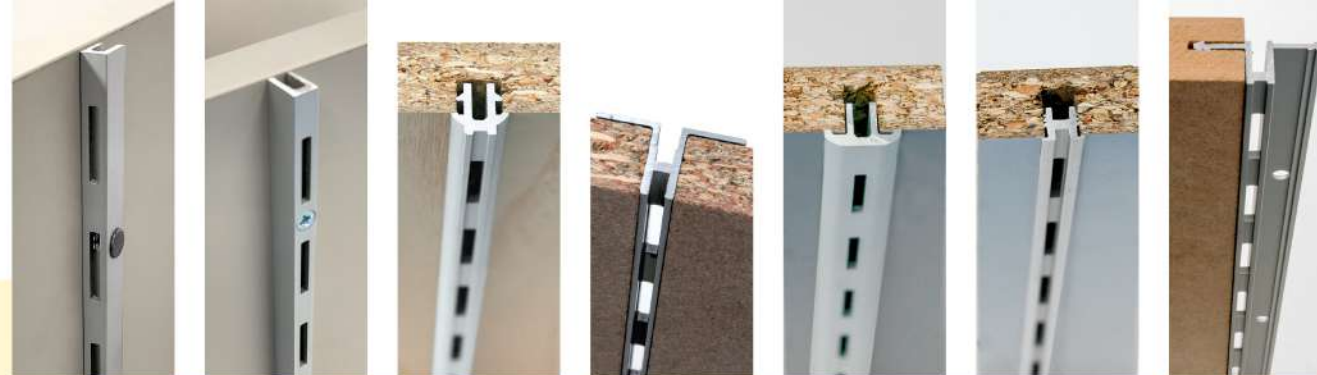

ELT

EFR

HLE

CF1

RLE

M7L

M6L

Cremagliere
Slotted profiles

Inserimento laterale in fresata o tramite foratura di fissaggio con passo 111 mm
Side insertion into milled panel or through fixing holes with 111 mm drilling pitch

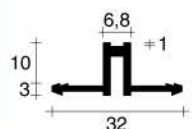

M6L.2013. ___ 2013
M6L.2531. ___ 2531
M6L.3012. ___ 3012

M6L

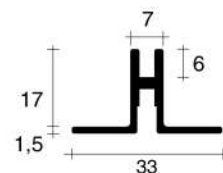
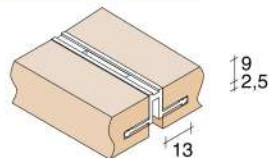

CF1.2849. ___ 2849 CF1

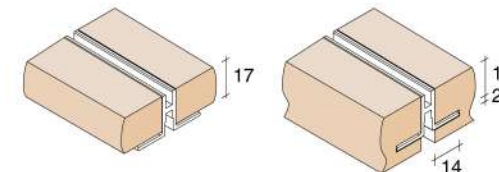

Incasso in fresata con vite a vista
Embedded on milling with visible frontal screw



EFR.2013. ___ 2013
EFR.3012. ___ 3012

EFR

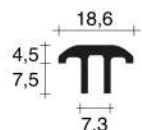
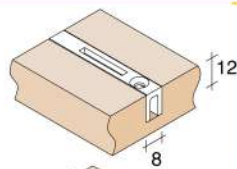

RLE.2013. ___ 2013
RLE.3012. ___ 3012

RLE

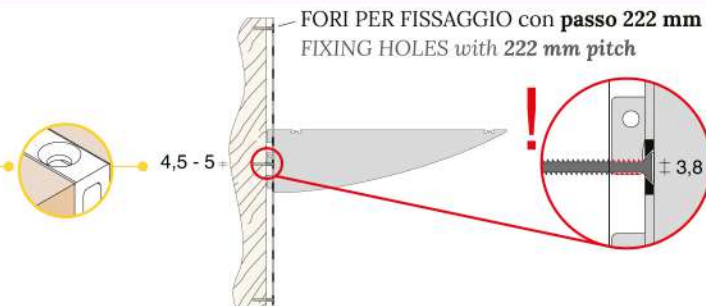
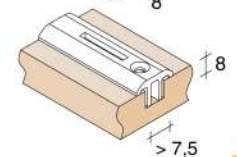

POSSIBILE INTERFERENZA fra dente del supporto e vite per tassello. Per ovviare a tale problema asportare del materiale dal supporto.

POSSIBLE INTERFERENCE between support tooth and screw. To solve this problem it is necessary to file the support's tooth.

Inserimento frontale in fresata
Frontally embedded on milling

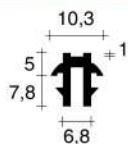

HLE.2013. ___ 2013
HLE.3012. ___ 3012

HLE

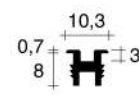
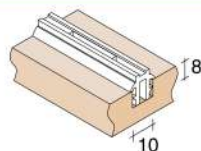

M7L.2013. ___ 2013
M7L.3012. ___ 3012

M7L

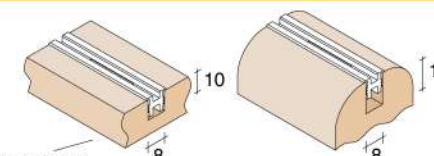

solo mini supporti
only mini supports

Appoggio laterale con vite a vista
Lateral support with visible screw



Codici Codes
ELT.3012. ___ 3012

ELT
singola
single

Tappo esterno di copertura del foro
Ø 7,2 mm
External hole covering cap Ø 7,2 mm

CAP.ELT9. ARG

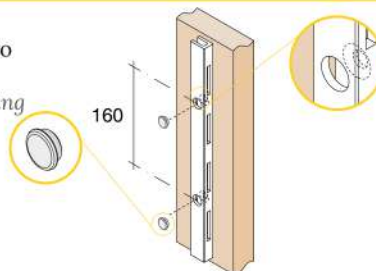

Finiture Finishings	Alluminio Aluminium	AI	AI
Argento satinato Satinized Silver	NAT	Brillante Brilliant	LUX
Nero Black	ANE	Finitura inox Inox finishing	NOX*
Dorato satinato Satinized gold	ORO	Dorato lucido Polished gold	DOL*
Lucido Brillante Bright	SLX		

codice code
XXX.XXXX.XXX*

Asterisco = la finitura potrebbe non essere in pronta consegna.
Asterisk = finishing not always ready in stock.

Finiture disponibili per profili H = 3012 mm
Finishing available for profiles H = 3012 mm

Quote espresse in millimetri.
Dimensions are in millimeters.

Accessori correlati
Related accessories

FIT
ART

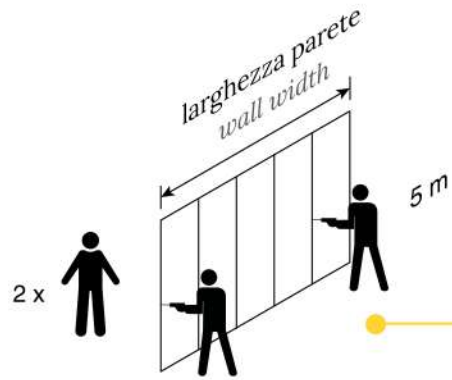

Sistema NB NB System	
Cremagliere NB Nb Slotted profiles	Rivestimento NB0 NB0 wall cladding
1 h 30'	2 h 30'

PK
6 h

CG
8 h

CR
6 h

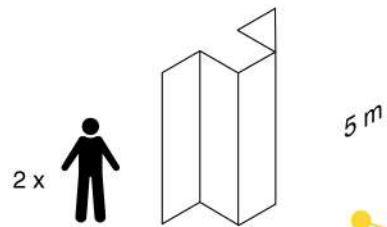

Angolo con NB9 Angle with NB9	Rivestimento NB0 NB0 wall cladding
3 h	5 h

PK-R19
-

-

Angolo con CR0 Angle with CR0
8 h

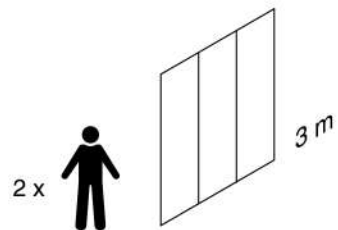

Cremagliere NB Nb Slotted profiles	Rivestimento NB0 NB0 wall cladding
1 h	2 h

4 h

5 h

4 h

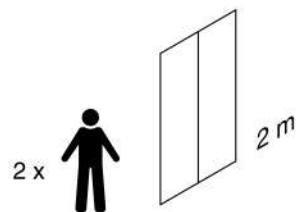

Cremagliere NB Nb Slotted profiles	Rivestimento NB0 NB0 wall cladding
45 min	1 h 30'

3 h

4 h

3 h 30'

Note tecniche

Technical data

CAPACITÀ DI CARICO

LOADING CAPACITY

Durante l'utilizzo di profili porta-piani in alluminio **si tengano presenti i seguenti fattori:**

- **STRATEGIA DI PRODUZIONE:** la progettazione di ogni profilo, la scelta della lega e le fasi di produzione sono integrate per ottenere da ciascuno di essi la qualità e la tenuta stabilite. La mancanza di questo accorgimento è la ragione per cui le riproduzioni dei nostri prodotti non hanno le necessarie caratteristiche di portata.
- **FISSAGGIO:** i profili sono realizzati per superare la tenuta del tassello a muro (mediamente 350 kg in condizioni ottimali), quindi è fondamentale che l'ancoraggio a parete sia opportunamente eseguito, anche per mezzo di telai quando necessario.
- **PROGETTAZIONE DELLE AMBIENTAZIONI:** le indicazioni di questo catalogo e la professionalità dell'installatore o del progettista, determinano la selezione del giusto profilo e della sua applicazione, secondo le finalità. Sono disponibili svariate opzioni: tipo di foratura - singola o doppia - e montaggio, asse centrale o laterale, distanze ed interassi ed i loro conseguenti accessori.

Keep in mind these factors during the use of aluminium profiles:

- **PRODUCTION STRATEGY:** The design of the different profile sections are decided in relation with the alloy choice and the manufacturing processes. It allows each item to reach the reference loading capacity. This is the main reason why replicated products, found sometimes in the market, do not reach the FitArt loading capacity characteristics.
- **FIXING:** Profiles are conceived in order to exceed the loading capacity of a 5 mm wall plug that reaches in average around 350 kg under normal operating conditions. It is very important to carry out the most suitable fixing to the wall, also using frames if necessary.
- **PLANNING AND DESIGN OF THE STRUCTURE:** The indications of this catalogue and the professional experience of a designer or an installer determine the choice of a right profile and its application. The different profiles options are available regarding: drilling types -single or double- and assembly, central or side load, distances and spans between profiles, and its related accessories.

PROVE DI CARICO

LOADING TESTS

I nostri profili a cremagliera sono sottoposti a severe **prove distruttive con simulazioni in laboratorio.**

Le immagini e il grafico qui riprodotti mostrano un nostro profilo standard, caricato su un singolo dente, resistere fin oltre 400 kg.

Our slotted profiles are subjected to very severe **destructive tests in laboratory simulations.**

The test here described shows a standard profile, with support loaded on a single tooth, standing over 400 kg.

Compressione cremagliera murale NB1

NB1 Wall slotted profile compression

TABELLA
DI DEFAULT
DEFAULT
TABLE

Modo di controllo 1
Velocità 1
Corsa 1
5 mm/min

Control 1
Speed 1
Run 1
5 mm/min

Risultati
Results

	Etichetta provino Label test	Carico compressione Compression load
1	T.01	> 438,819 [daN]

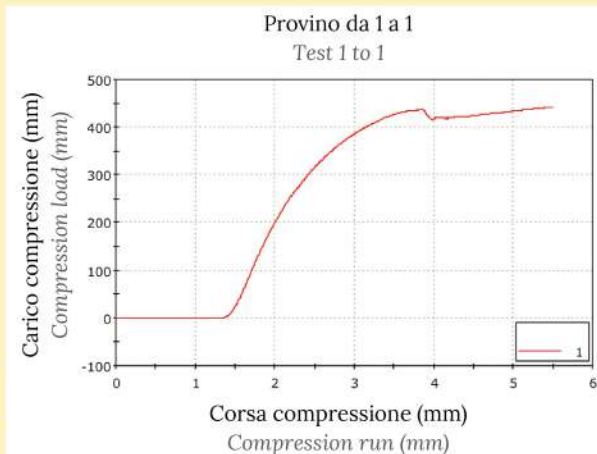

Sezione
cremagliera
Profile
section

Supporto
caricato
Support
loaded

Provino
Test

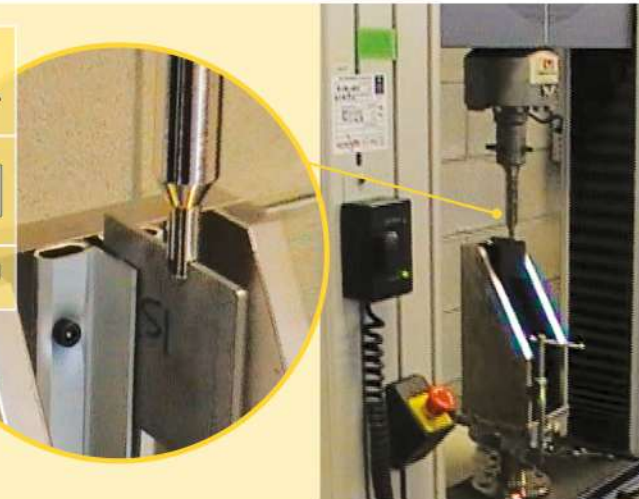
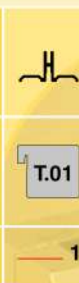

Decliniamo ogni responsabilità per l'utilizzo dei nostri profili con supporti non di nostra produzione, e viceversa, in particolare se prodotti in acciaio inossidabile.

Fit Art disclaims any responsibility for the use of our profiles with supports not of our production, and vice versa, especially the ones realized in stainless steel.



SOLLECITAZIONI AL CARICO

LOADING REACTION

Un carico puntuale su un profilo a cremagliera produce gli stessi effetti di una leva di primo genere (palanchino): **aumentando la distanza dal fulcro (braccio della leva) aumenta proporzionalmente l'effetto della leva.**

The effect of a localized load on a slotted profile is similar to the action of a force applied to a lever (such as a crowbar): **with an increase of the distance (lever arm) from the fulcrum, the lever increases proportionally.**

Ipotesi di comportamento lineare

Hypothesis of linear behaviour

Carico interno al supporto
Inside support load

kg	cm
60	10
30	20
20	30

STESSO EFFETTO DI SOLLECITAZIONE
SAME STRESS EFFECT

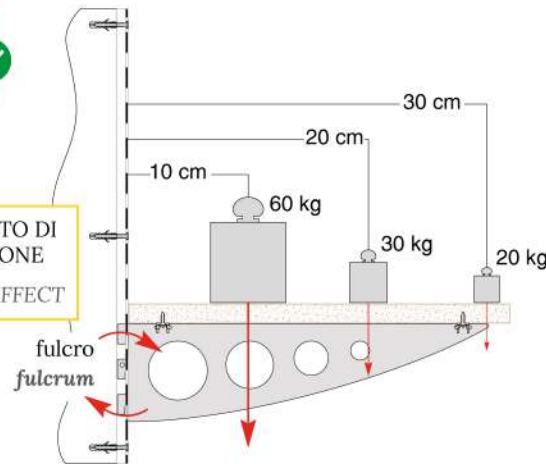

Carichi a sbalzo: comportamento non lineare

Overhang load: no more valid linear behaviour

Carico a sbalzo
Overhang load

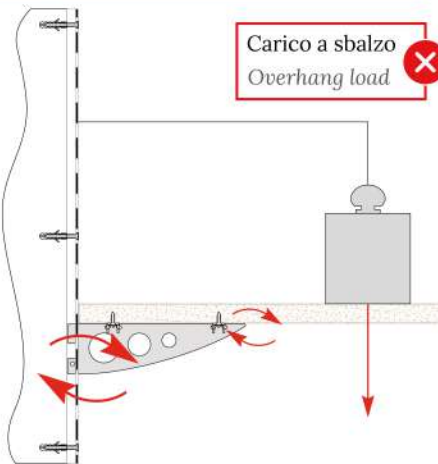

CATEGORIE DI PORTATA

LOADING CATEGORIES

Poiché dai dati tecnici finora considerati **non si può assegnare alcuna portata nominale.**

A titolo puramente indicativo abbiamo suddiviso i profili in categorie di portata subordinate alle **sezioni** ed alla **disposizioni degli ancoraggi.**

According to the technical data provided in these pages, it becomes very difficult to assign a nominal loading capacity in average conditions.

Anyway the profiles can be divided into the following loading categories, considering the **section dimension** and how the **fixings are positioned.**



ALTA
HIGH

- Profili
- con fissaggi doppi
 - con tanti punti di ancoraggio
 - inseriti all'interno di montanti

- Profiles
- with double fixings
 - with many anchor points
 - inserted into the uprights

NB1 / NB2
LMK + HLE
CG1 / CG2
PK1 / PK2
RMC + TCN
RP1 / RP2
RDC + RD2
FDC + RD2



MEDIA
MEDIUM

- Profili
- con fissaggi doppi con passo maggiore di 20 cm
 - con fissaggi su un lato a meno di 20 cm di distanza

- Profiles
- with double fixings with more than 20 cm pitch
 - with single side fixings at less than 20 cm distance

NB7 / NB3
CR1 / CR2
CG7 / PK7



BASSA
LOW

- Profili
- con fissaggi su un lato con passo maggiore di 20 cm
 - CONCEPITI PER INCASSO con sezioni contenute

- Profiles
- with single side fixings at more than 20 cm
 - profiles with restrained section
CONCEIVED TO BE EMBEDDED

CR7
serie ad
incasso

CR7
embedded
series

Quote espresse in millimetri.
Dimensions are in millimeters.

Accessori correlati
Related accessories