

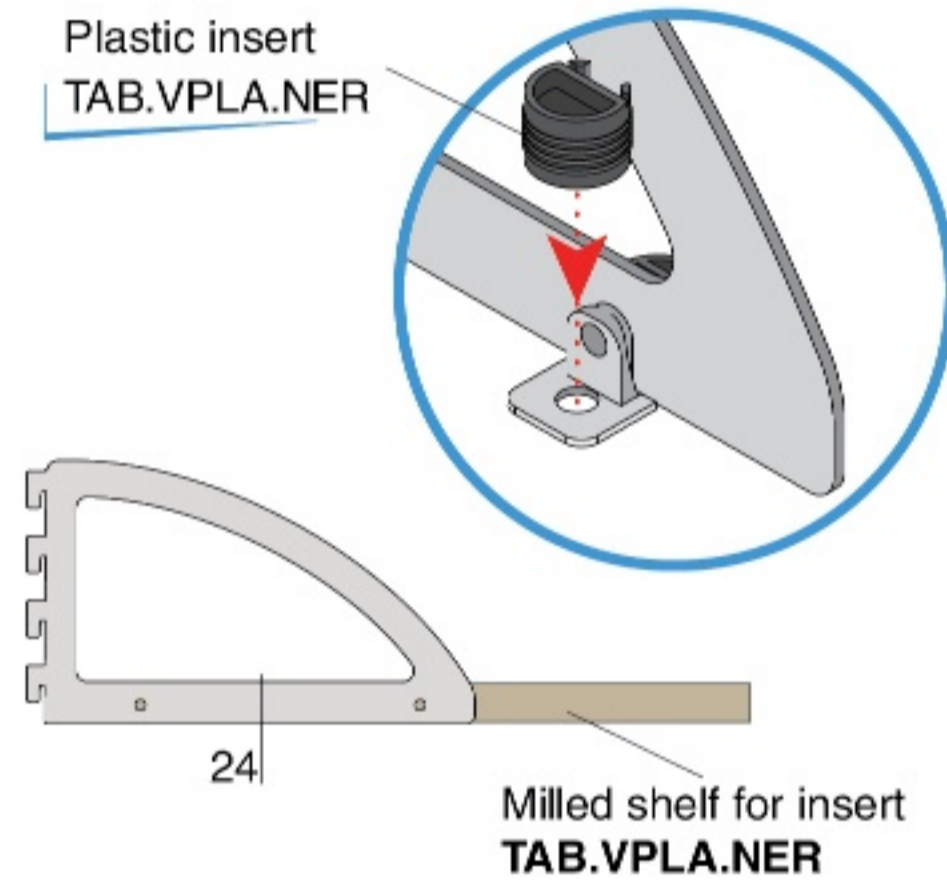

SUPPORTS WITH TAB INSERT

BL series

AI NAT
* LUX

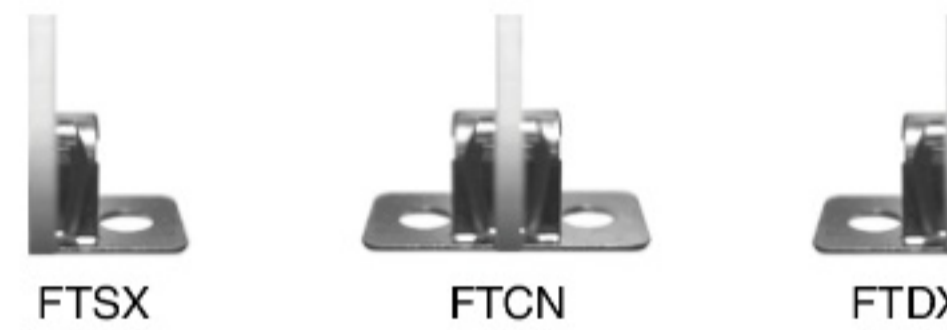
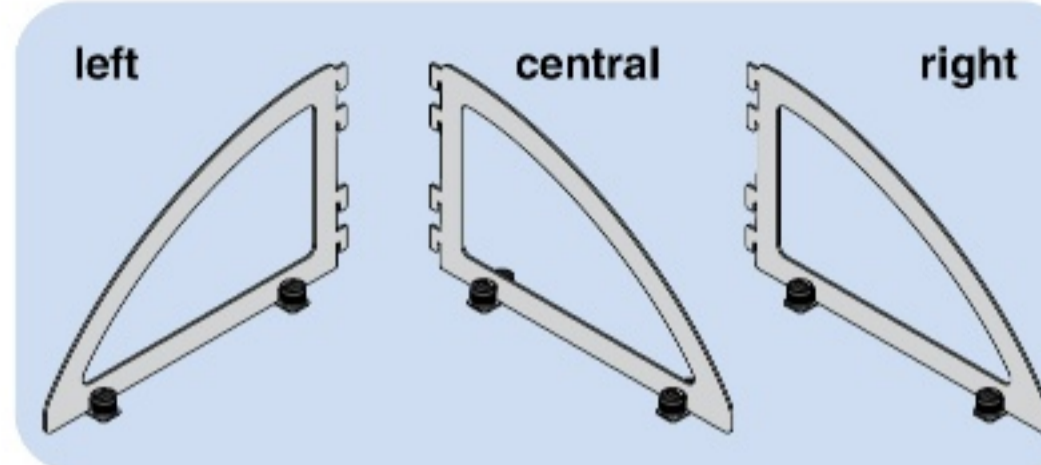
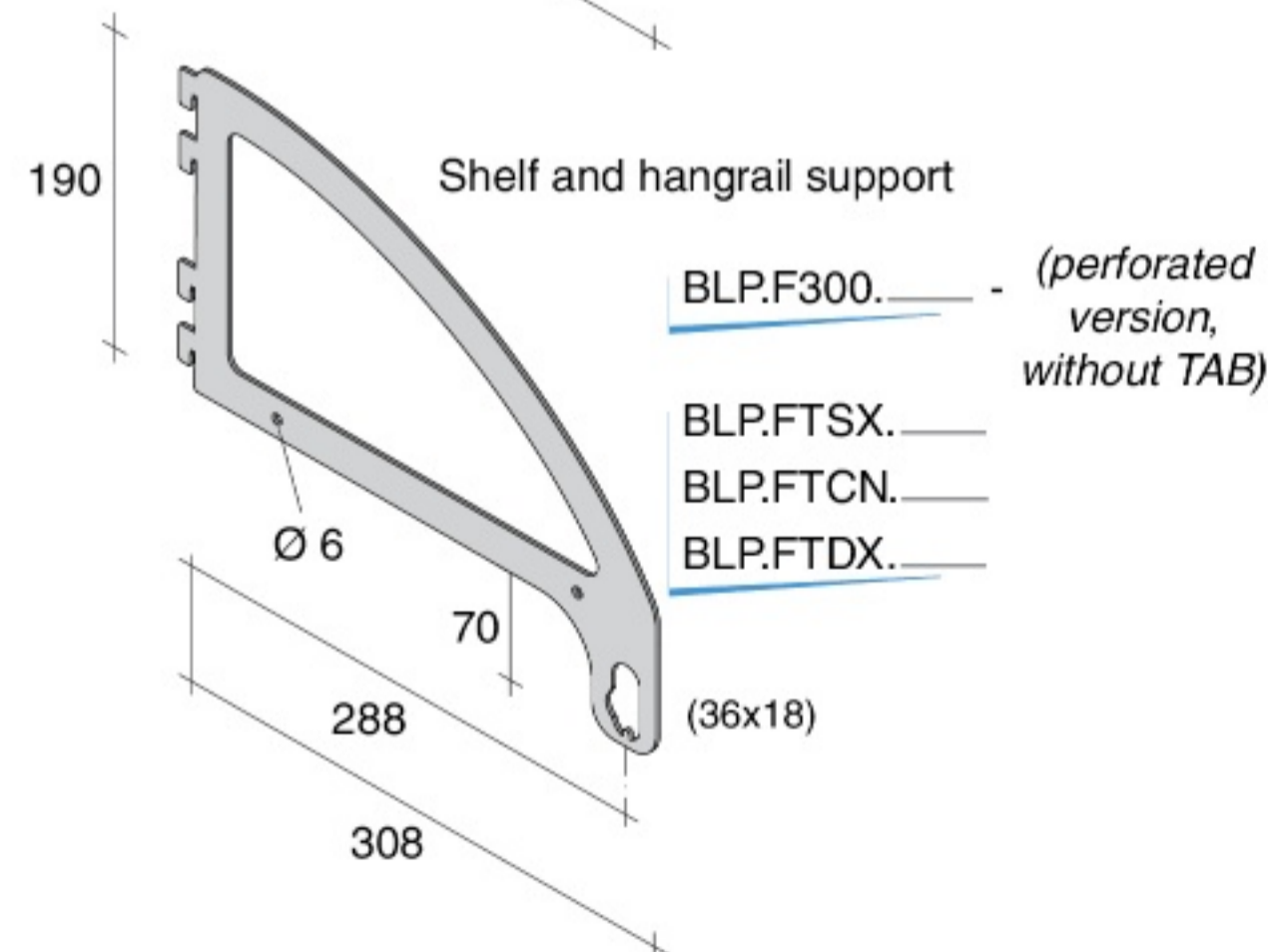
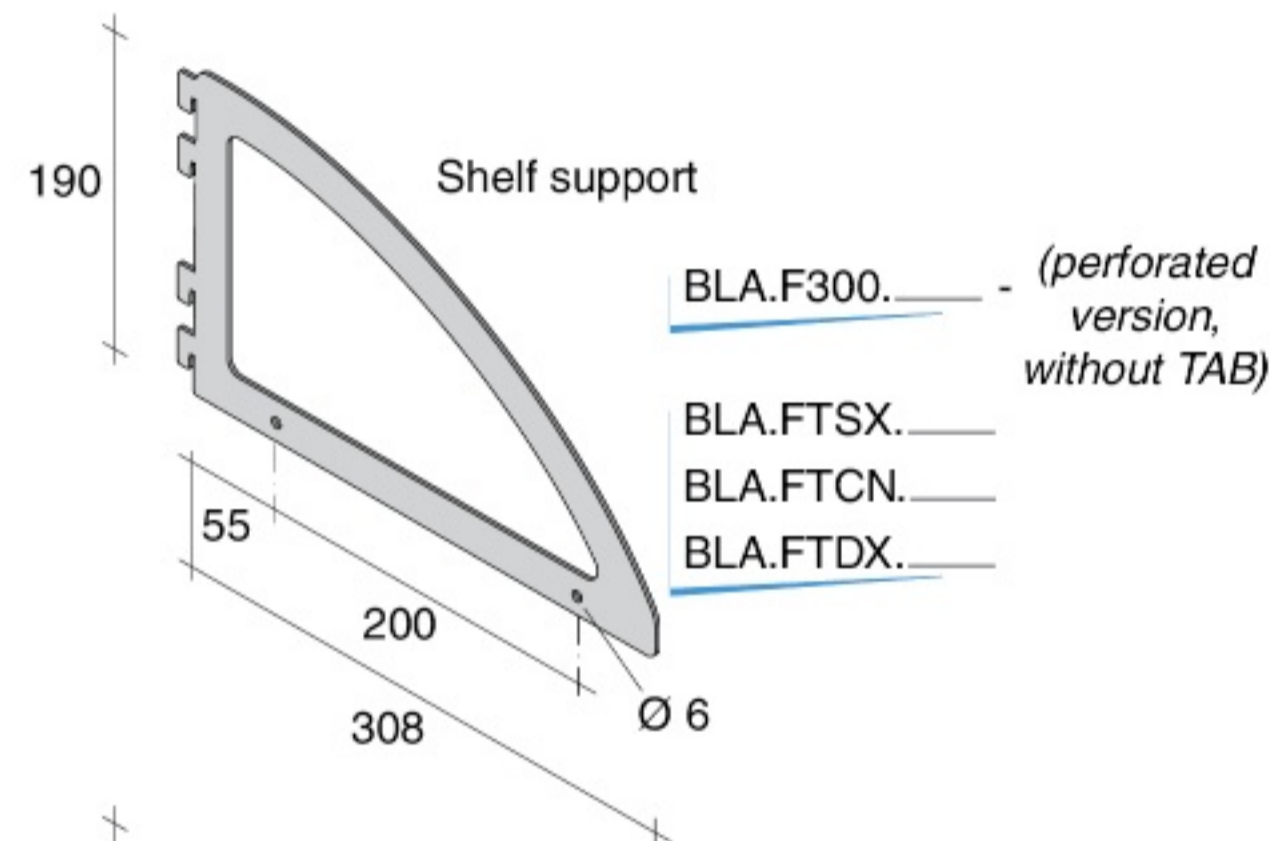
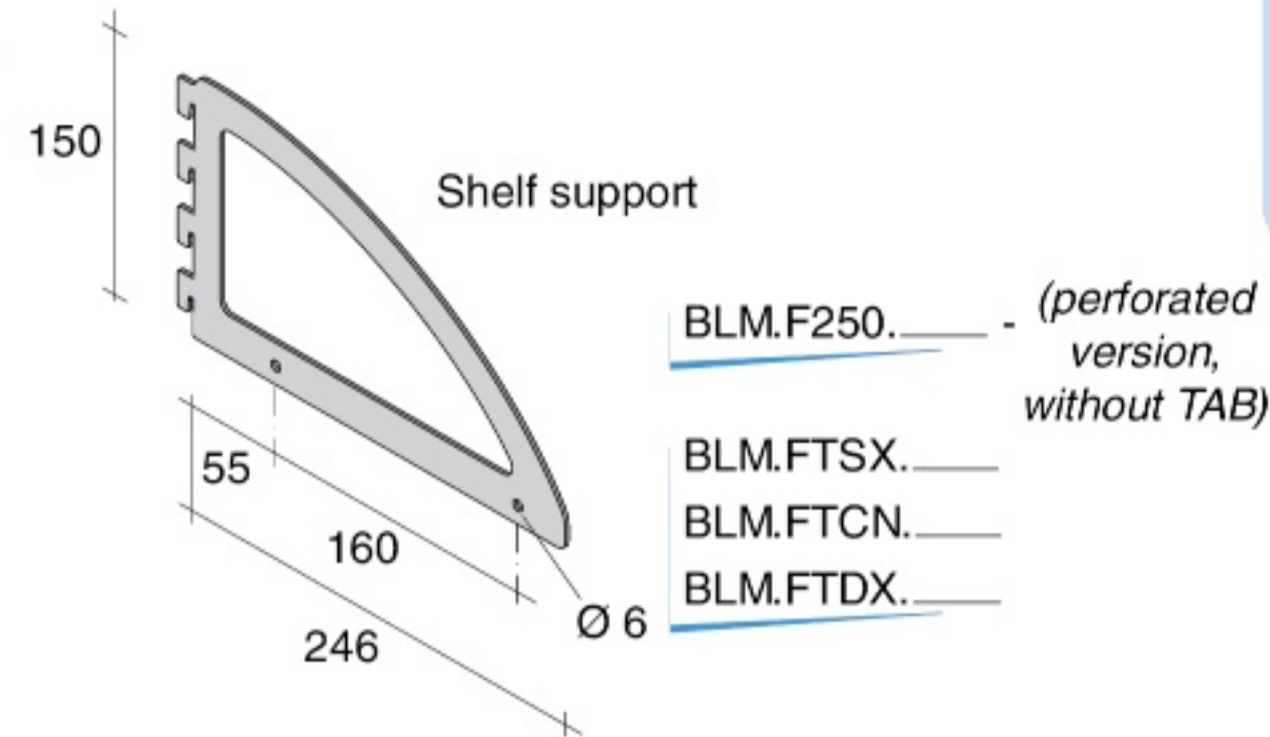

If you intend to carry out this procedure with TAB insert we advise you to buy the following professional tools from **HÄFELE** company:

- rif. Art. 001.25.511
for the TEMPLATE FOR TAB V 16-29 mm

- rif. Art. 001.24.452
for the DRILL BIT TAB V HM DS. 18 mm

- rif. Art. 001.42.665
to limit the depth of the drilling stroke

ASSEMBLY INSTRUCTION FOR SUPPORTS WITH TAB ACCESSORY

1) TOOLING ON UNDERSIDE OF THE SHELF
minimal thickness **18 mm**

profile	d
NB - RP	45
PK - CG	48
CR	54

DRILLING DATA
- drilling distance:
160 / 200 mm;
- milling: **Ø 18 mm**;
- depth: **15 mm**;
- drilling distance from the shelf edge: **8,2 mm**.

d = distance between slotted profile edge and first TAB insert

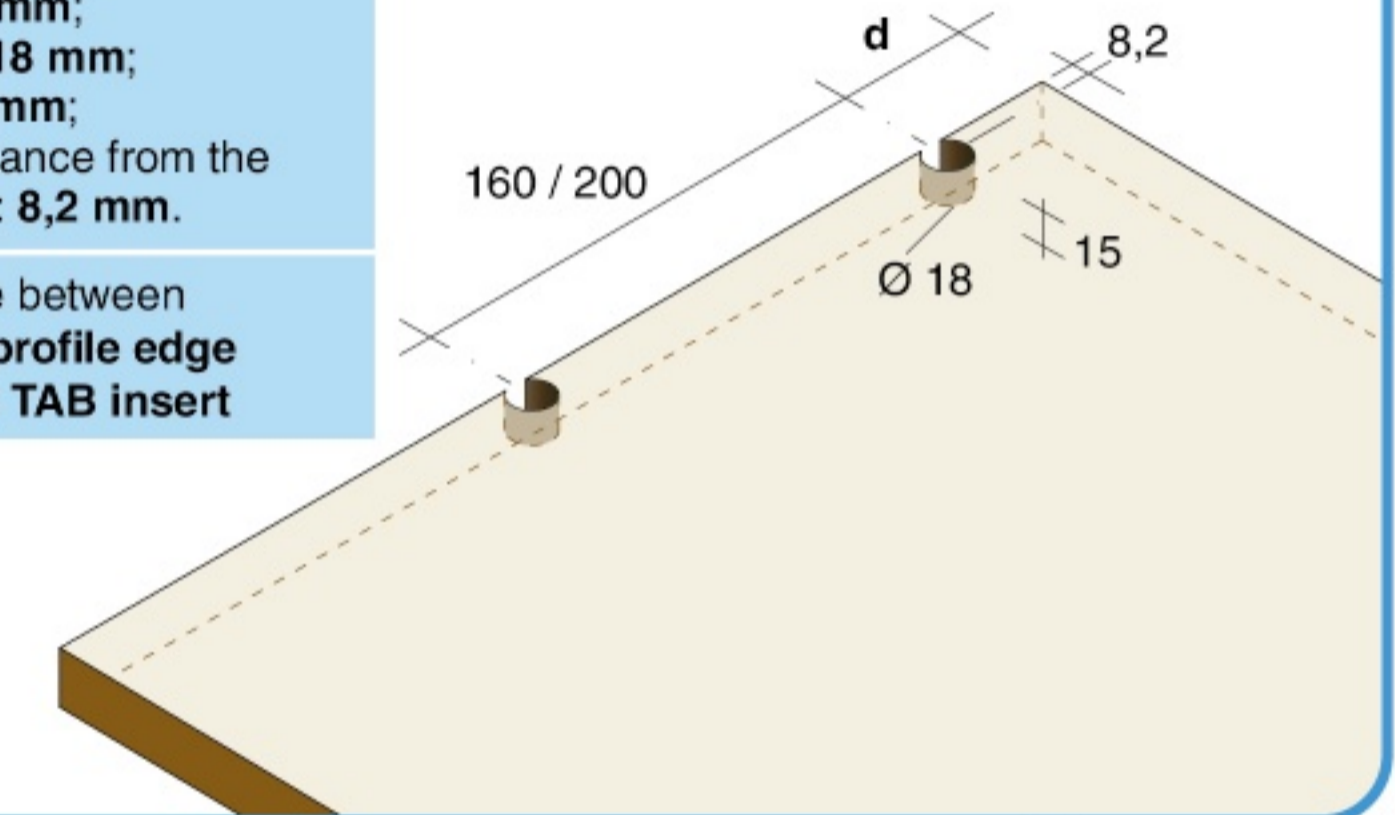

2) FIXING OF THE MILLED SHELF TO THE SUPPORT (BL series)

It allows you to move your supports on slotted profile without removing the shelf.

Block **TAB.VPLA.NER** with $\frac{1}{4}$ turn of a screwdriver.

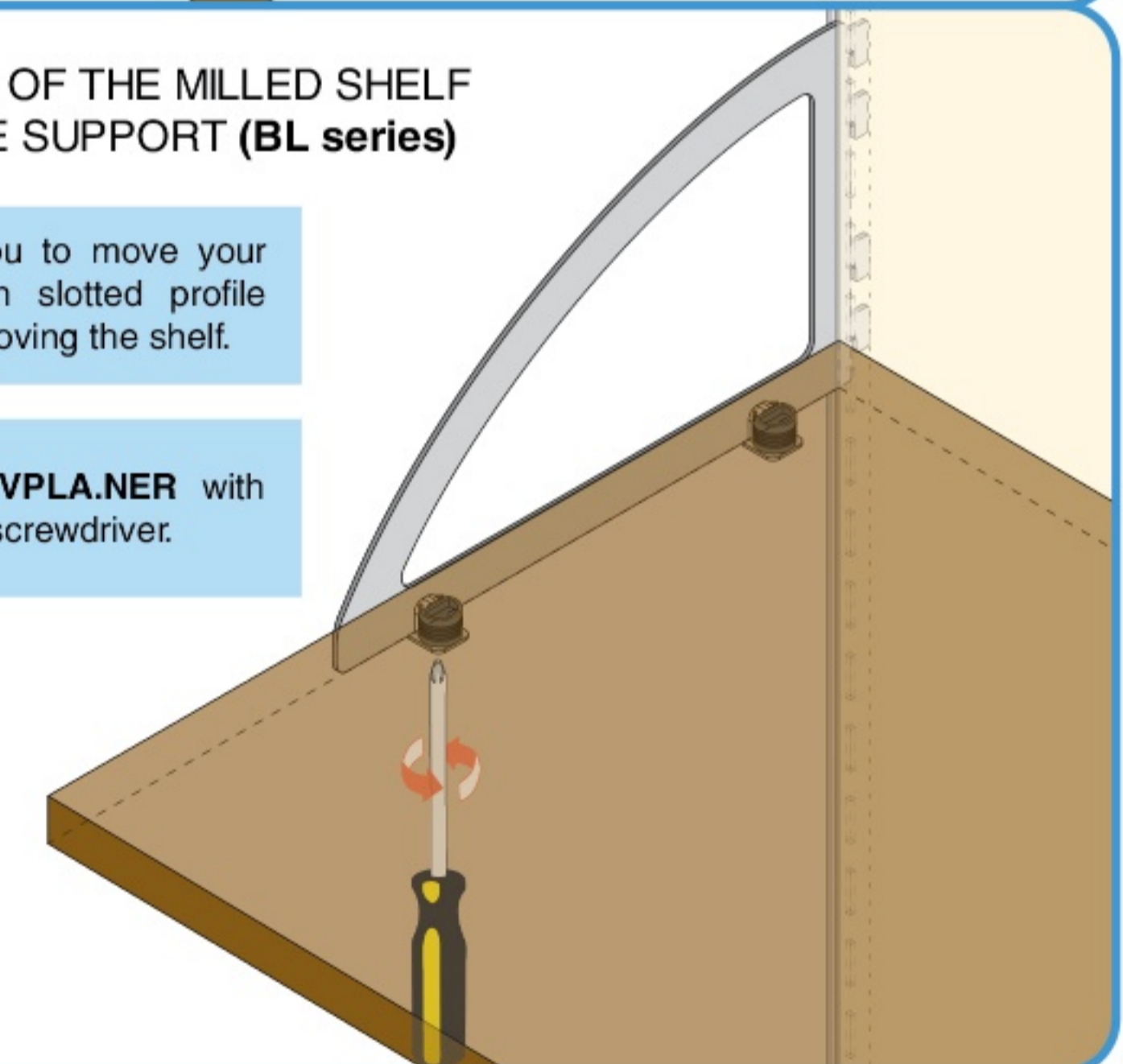

LOADING CAPACITIES on PAGE 67

LOADING capacities

NHS

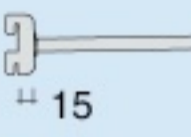

page 38

Specific for wood shelves	Model	Length [mm]	Height [mm]	Load Aluminium	Load Steel
 Ø12	NHS.0010	165	55		90 kg
 15	NHS.0015	170	55		90 kg

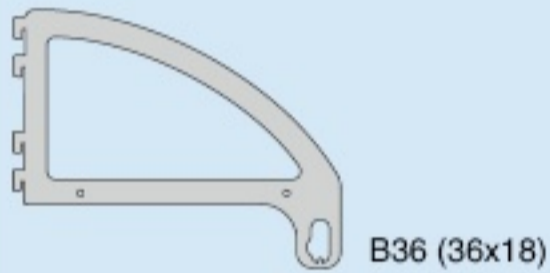
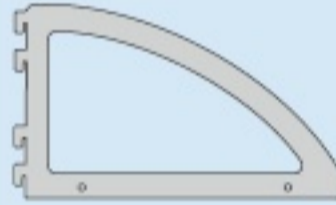
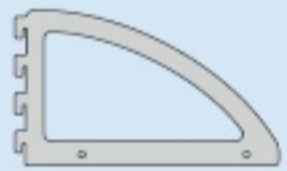

BL

page 37

Specific for wood shelves	Model	Length [mm]	Height [mm]	Load Aluminium	Load Steel
 B36 (36x18)	BLP.F300	305	250	70 kg	
	BLA.F300	305	190	70 kg	
	BLM.F250	245	150	70 kg	

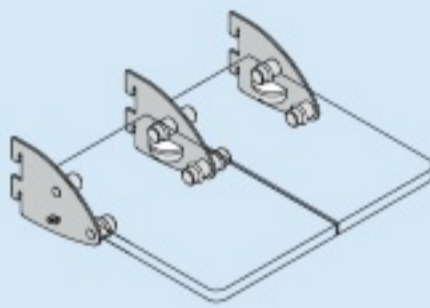

DWA

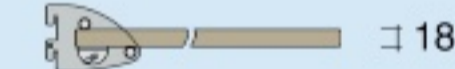
page 38

Specific for wood shelves	Model	Length [mm]	Height [mm]	Load Aluminium	Load Steel
	DWA.DX				
	DWA.SX	90	70	50 kg	
 18	DWA.CN				

CTL

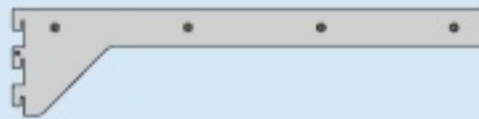

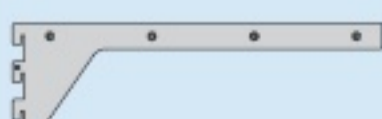
page 36

Specific for wood shelves	Model	Length [mm]	Height [mm]	Load Aluminium	Load Steel
	CTL.DX45 CTL.SX45	450	105	30 kg	40 kg
	CTL.DX40 CTL.SX40	400	100	30 kg	40 kg
	CTL.DX35 CTL.SX35	350	100	25 kg	35 kg

CMO.G

CTA.G

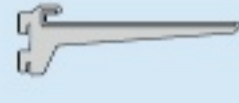

page 51

Specific for glass shelves	Model	Length [mm]	Height [mm]	Load Aluminium	Load Steel
	CMO.G19	205	65	30 kg	40 kg
	CTA.G19	204	67	30 kg	40 kg
	CTA.G29	304	102	40 kg	50 kg

Z

openwork

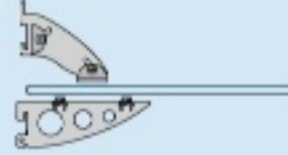

page 53

Specific for glass shelves	Model	Length [mm]	Height [mm]	Load Aluminium	Load Steel
	Z14	140	130	35 kg	45 kg
	Z18	180	135	35 kg	45 kg
	Z23	230	140	35 kg	45 kg

Z

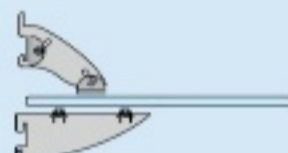

solid



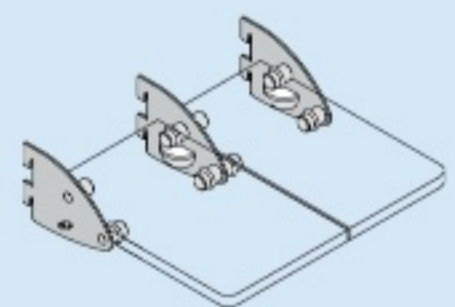

page 53

Specific for glass shelves	Model	Length [mm]	Height [mm]	Load Aluminium	Load Steel
	Z14	140	130	35 kg	45 kg
	Z18	180	135	35 kg	45 kg
	Z23	230	140	35 kg	45 kg

DWA

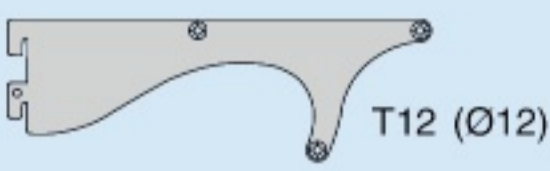
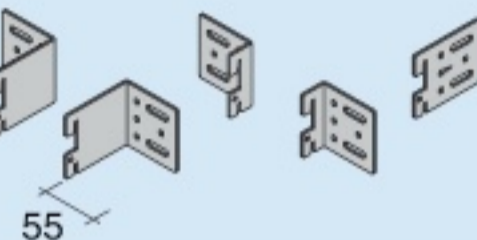
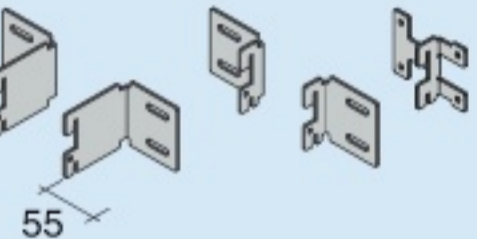
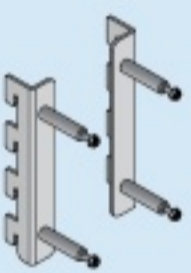
page 51

Specific for glass shelves	Model	Length [mm]	Height [mm]	Load Aluminium	Load Steel
	DWA.DX08 DWA.SX08 DWA.CN08				
 8	DWA.DX10 DWA.SX10 DWA.CN10	90	70	50 kg	
 10					

	Specific accessories	Model	Length [mm]	Height [mm]	Load Aluminium	Load Steel
SKA Shoe rack page 56	 T12 (Ø12)	SKA.DX03 SKA.SX03 SKA.CN03	236	83	5 kg	
PAK page 58	 55	PAK.DX PAK.SX	10 / 50	55		100 kg
PAT page 58	 55	PAT.DX PAT.SX	10 / 50	55		100 kg
MFX page 59		MFX.DX96 MFX.SX96	11	140		100 kg
GNC page 63		GNC.D302	45	56	10 kg each	20 kg each
TAC page 63		TAC.L700	20	37	10 kg	20 kg each
		TAC.T700	24	15	10 kg	

Loading capacity evaluation for single element, on 4 resting points.

LOADING CAPACITY EVALUATION METHOD

The capacities indicated here refer to a couple of supports with saddles that undergo the following loading test:

- Assembly of 2 slotted profiles, perfectly parallel, suitably fixed at 60 cm distance from each other and fixed to the wall according to the instruction;
- fixing of 2 Fit Art supports to the slotted profiles at the equal height;
- assembly of 4 saddles, two for each support;
- positioning of a 70 cm length shelf on supports, equipped with saddles, with 5 cm overhang on each side (for saddles see pag. 35);
- positioning of the load centered on the shelf (the load is evenly distributed to simulate real application).

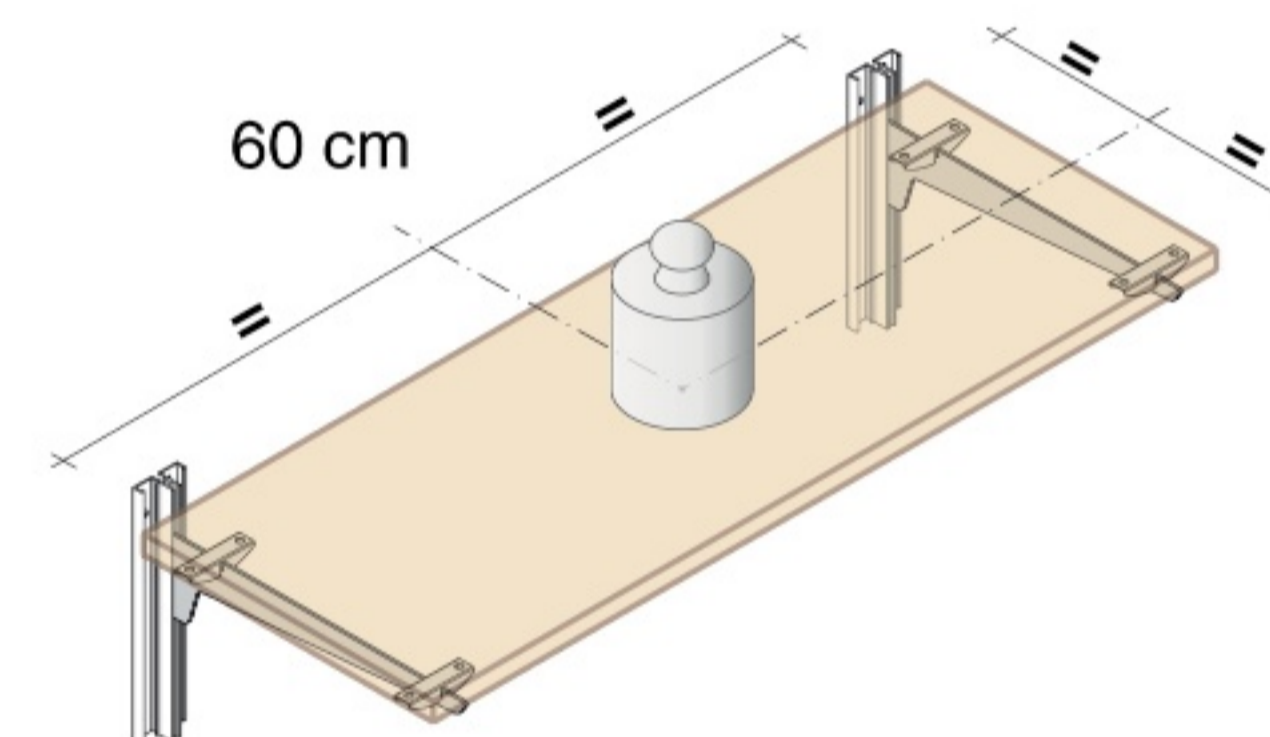

All other Fit Art supports without saddles need to be assembled according to the instruction procedure.

The capacities indicated in the load chart are the **half** of the breaking load.



For the couple of supports that exceed the limit of 200 kg, imposed during loading test, the value 100 kg is indicated.

The loading capacities of all Fit Art products result from the synergy between the manufacturing processes and the items shapes. The slavish reproduction of our products does not determine the same standards of hardness.