

Serie R

Monofacciali regolabili a parete

R Series

Adjustable wall frontal panelling upright



Montanti assemblati: R54 + SISTEMA NB

Assembled uprights: R54 + NB system

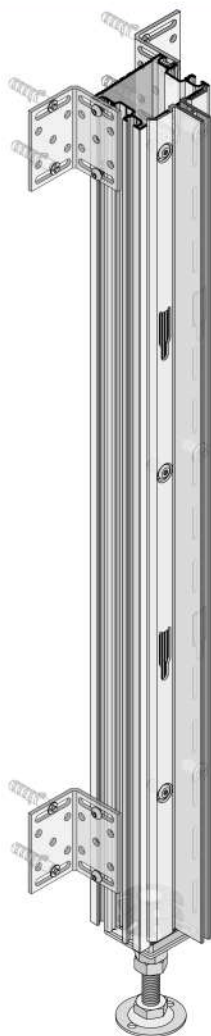

Elementi centrali Central elements

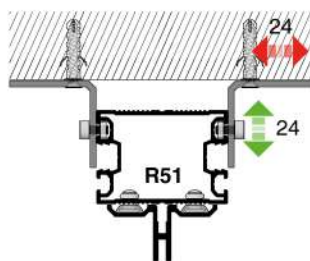

R51.2531. __ 2531
R51.3012. __ 3000

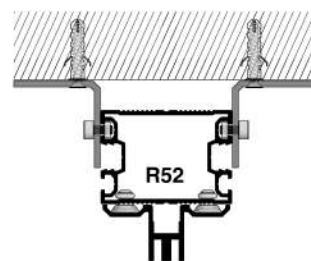

R52.2531. __ 2531
R52.3012. __ 3000

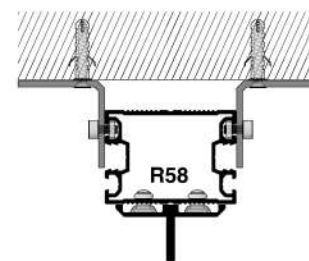

R58.2531. __ 2531
R58.3012. __ 3000

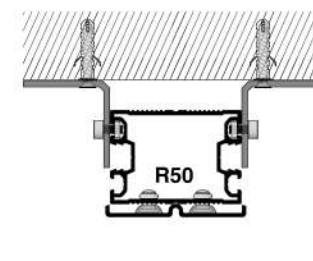

R50.2531. __ 2531
R50.3012. __ 3000

Elementi terminali Terminal elements

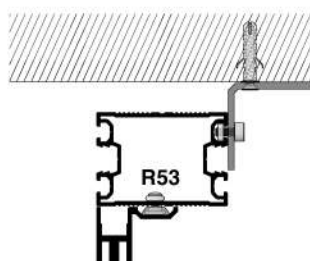

R53.25SX. __ 2531
R53.30SX. __ 3012
R53.25DX. __ 2531
R53.30DX. __ 3012

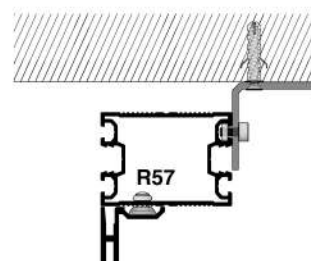

R57.25SX. __ 2531
R57.30SX. __ 3012
R57.25DX. __ 2531
R57.30DX. __ 3012

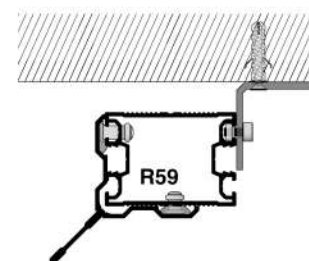

R59.25SX. __ 2531
R59.30SX. __ 3012

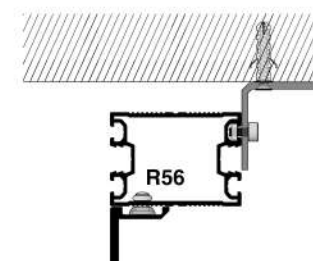

R56.25SX. __ 2531
R56.30SX. __ 3012
R56.25DX. __ 2531
R56.30DX. __ 3012

Finiture Finishings	Alluminio Aluminium	AI
Argento satinato Satinized Silver		NAT
Nero Black		ANE
Superficie simil-acciaio inox Stainless steel optical		SSO
Brillante Brilliant		LUX*
Finitura inox Inox finishing		NOX*
Dorato lucido Polished gold		DOL*

codice code
XXX.XXXX.XXX*

Asterisco = la finitura potrebbe non essere in pronta consegna.
Asterisk = finishing not always ready in stock.

Finiture disponibili per profili H = 3012 mm
Finishing available for profiles H = 3012 mm

Quote espresse in millimetri.
Dimensions are in millimeters.

Accessori correlati
Related accessories

Serie R

Autoportanti bifacciali per rivestimento

R Series

Double side panelling self standing upright

Montanti assemblati: R54 + SISTEMA NB

Assembled uprights: R54 + NB system



Cremagliere
Slotted profiles

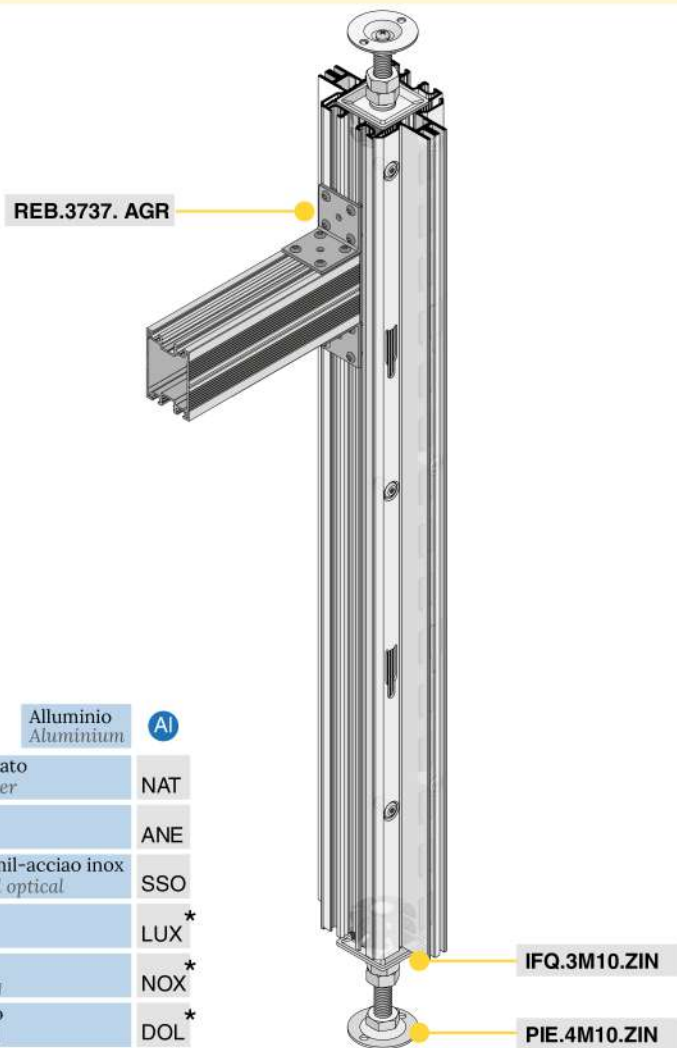

Elementi centrali : alcune fra le possibili combinazioni

Central elements: some of the possible combinations

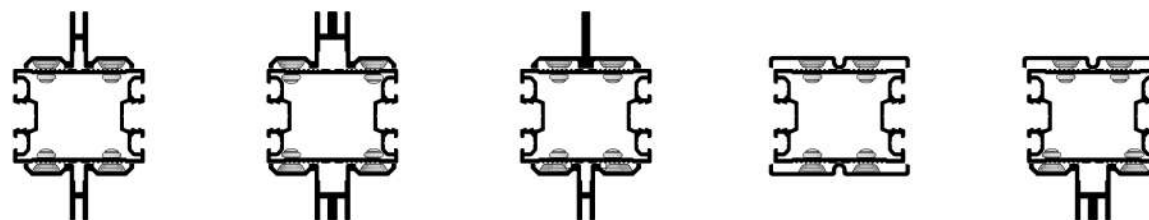

Elementi terminali : alcune fra le possibili combinazioni

Terminal elements: some of the possible combinations

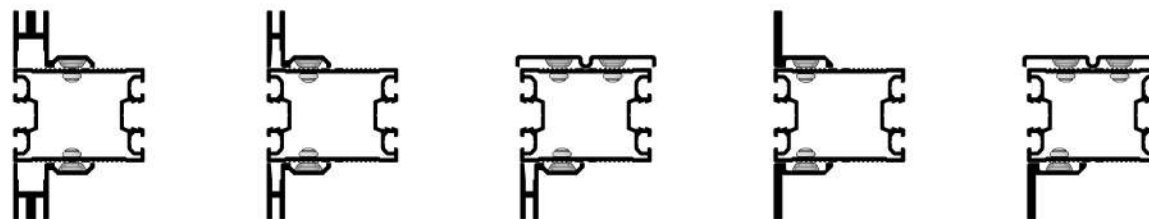

Finiture Finishings	Alluminio Aluminium	AI
Argento satinato Satinized Silver		NAT
Nero Black		ANE
Superficie simil-acciaio inox Stainless steel optical		SSO
Brillante Brilliant		LUX*
Finitura inox Inox finishing		NOX*
Dorato lucido Polished gold		DOL*



Combinazioni a richiesta
Combinations on request

codice code
XXX.XXXX.XXX*

Asterisco = la finitura potrebbe non essere in pronta consegna.
Asterisk = finishing not always ready in stock.

Finiture disponibili per profili H = 3012 mm
Finishing available for profiles H = 3012 mm

Quote espresse in millimetri.
Dimensions are in millimeters.

Accessori correlati
Related accessories

FIT
ART

R54

MONTANTE R54

Struttura di supporto per sistema NB, regolabile su tre assi

R54

R54 UPRIGHT

Support structure for NB system, adjustable on three axes

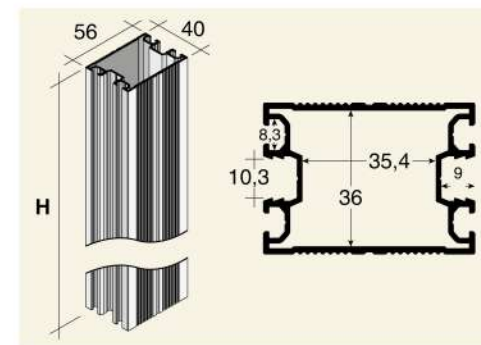

Montante auto-portante o murale, fissato con staffe regolabili, sul quale rivettare i profili della serie NB

Self standing or wall upright, fixed with adjustable brackets, on which the NB profiles can be riveted

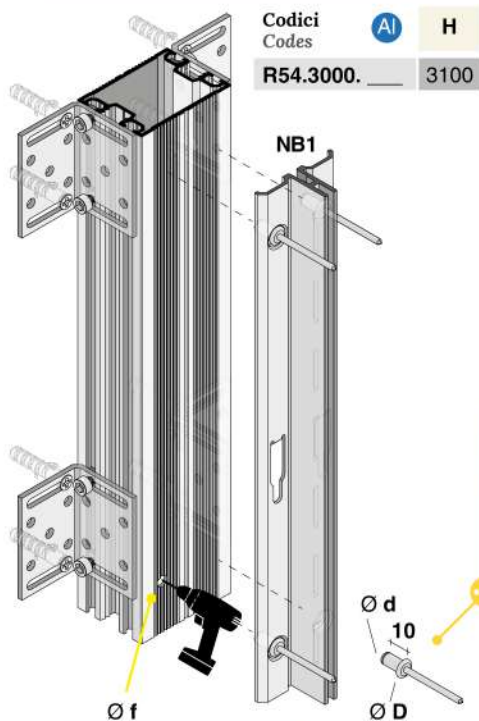

Codici Codes **Al** **H**
R54.3000. ___ 3100

rivetto standard a testa cilindrica max Ø 4,8 mm, per il fissaggio dei profili NB al montante R54
cylindrical head standard rivet, up to Ø 4.8 mm, to fix profiles to R54 upright

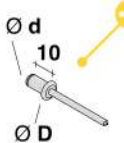

	f	d	L	D	[kg]	[kg]	[mm]
RIV.4010.AGR	4,1	4	10	8	~200	~140	~4,5-6,5
RIV.4810.AGR	5	4,8	10	10	~310	~210	~4-6
RIV.4820.AGR	5	4,8	20	10	per / for NB9		

preforare per inserire la testa del rivetto
pre-drill to insert the rivet head

Finiture Finishings **Alluminio Aluminium** **Al**
Grezzo Raw **AGR**

Regolazione secondo le 3 direzioni

Adjustable in 3 directions

inserto con flangia filettato M10
flanged threaded insert M10

IFQ.3M10.ZIN

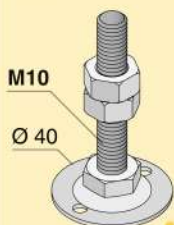

PIE.4M10.ZIN

piedino regolabile
 adjustable foot

staffa di fissaggio regolabile
adjustable fixing bracket

REB.3755.AGR

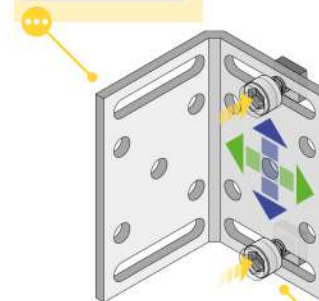

M4 8 **DAQ.08M4.ZIN**



premere contemporaneamente entrambe le viti per permettere lo scorrimento
press both screws simultaneously to allow the sliding

codice code
XXX.XXXX.XXX*

Asterisco = la finitura potrebbe non essere in pronta consegna.
Asterisk = finishing not always ready in stock.

Finiture disponibili per profili H = 3012 mm
Finishing available for profiles H = 3012 mm

Quote espresse in millimetri.
Dimensions are in millimeters.

Accessori correlati
Related accessories

Fit ART

Serie R

R Series

CONFIGURAZIONI ED USI
del montante strutturale per il sistema NB

CONFIGURATIONS AND USES
of the structural upright for the NB system

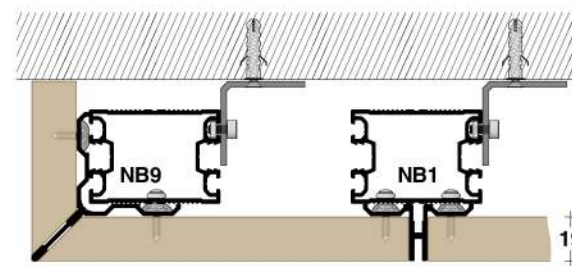
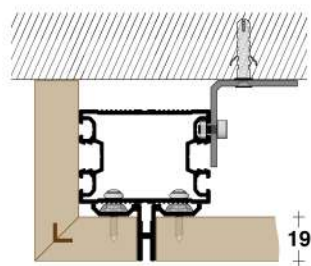
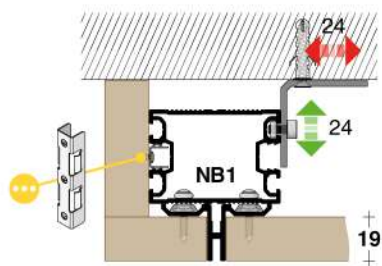

▲ **Ingombro**
Overall
dimensions
Min = ~ 45
Max = ~ 69

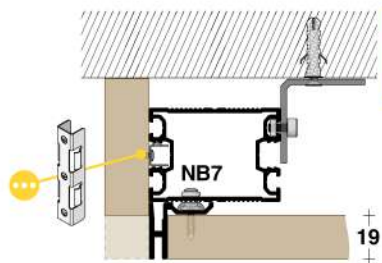

Montaggio regolabile a muro
Adjustable wall assembly

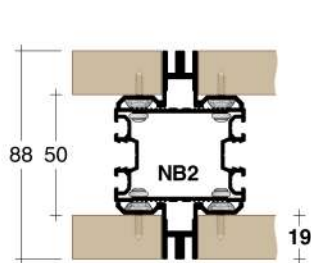

Autoportante ad espansione
Expansion self-standing upright

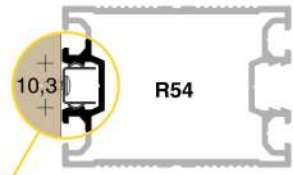
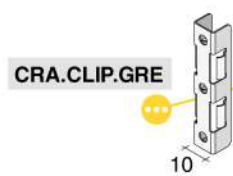

spazio per accogliere le clips avvitate sul retro del pannello di tamponamento laterale
gap to insert the clips screwed on the backside of the lateral finishing panel

