

BASES WITH THREADED FERRULE M8

L = length

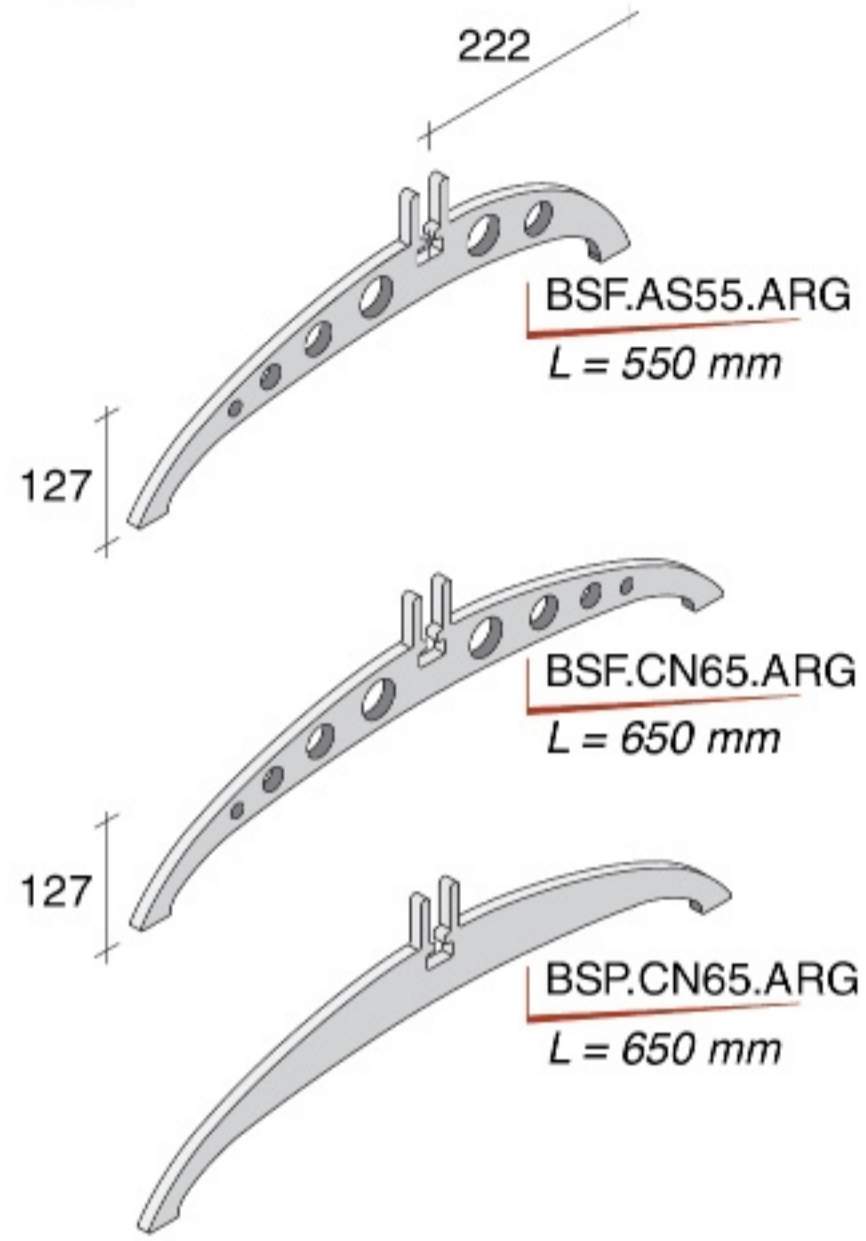
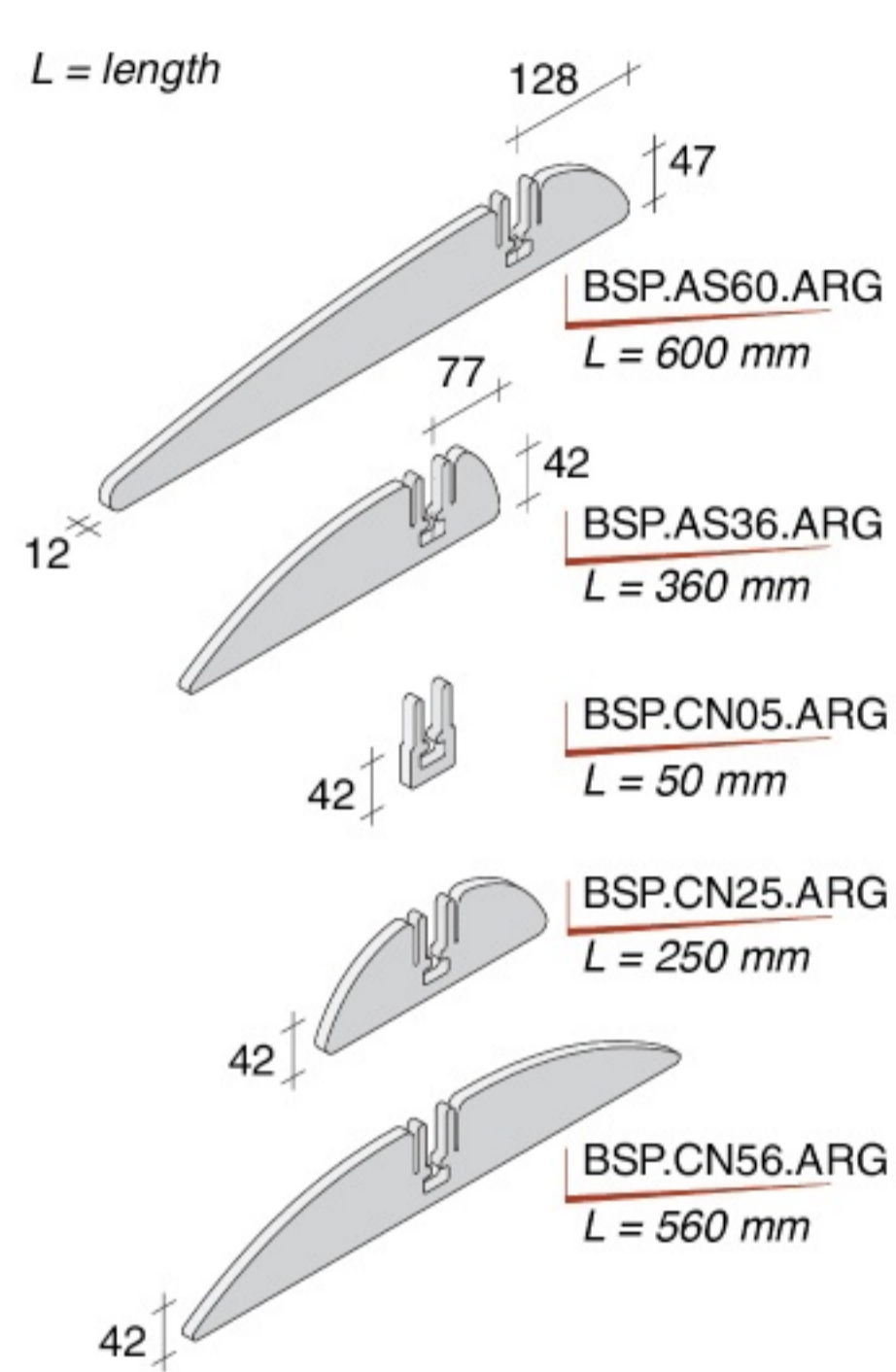

Support plate for
SLK and SCK coverings

BAS.HCOP.ZIN

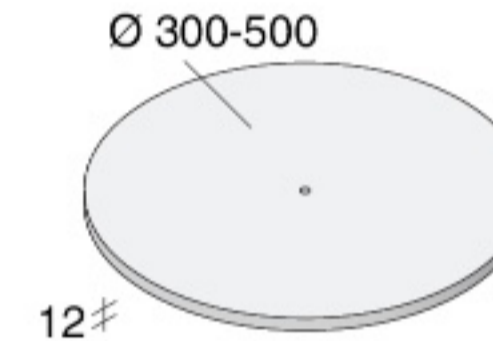
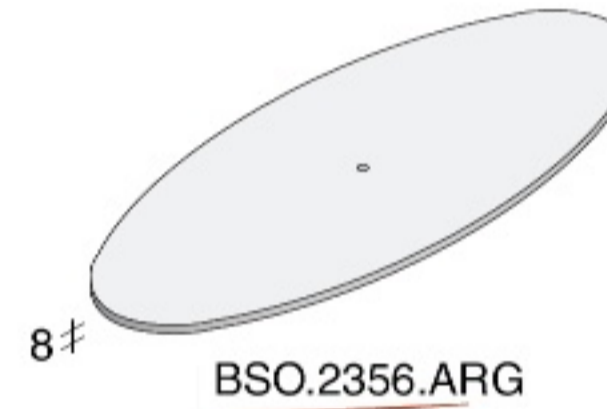
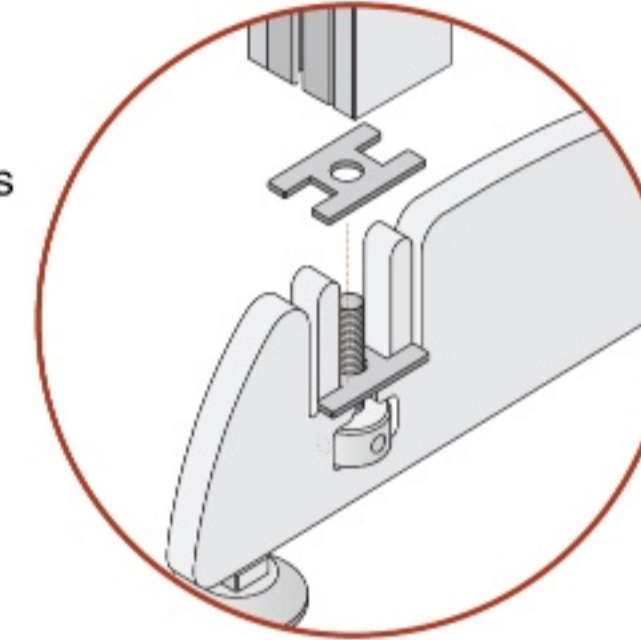

PIE.AL10.LUX



BSP.CN65.ARG with PIE.AL08.NAT



BSP.AS60.ARG with PIE.AL08.NAT

FEET

Plastic
tilting foot
M8 and M10

UNSUITABLE
for ceiling-floor
application

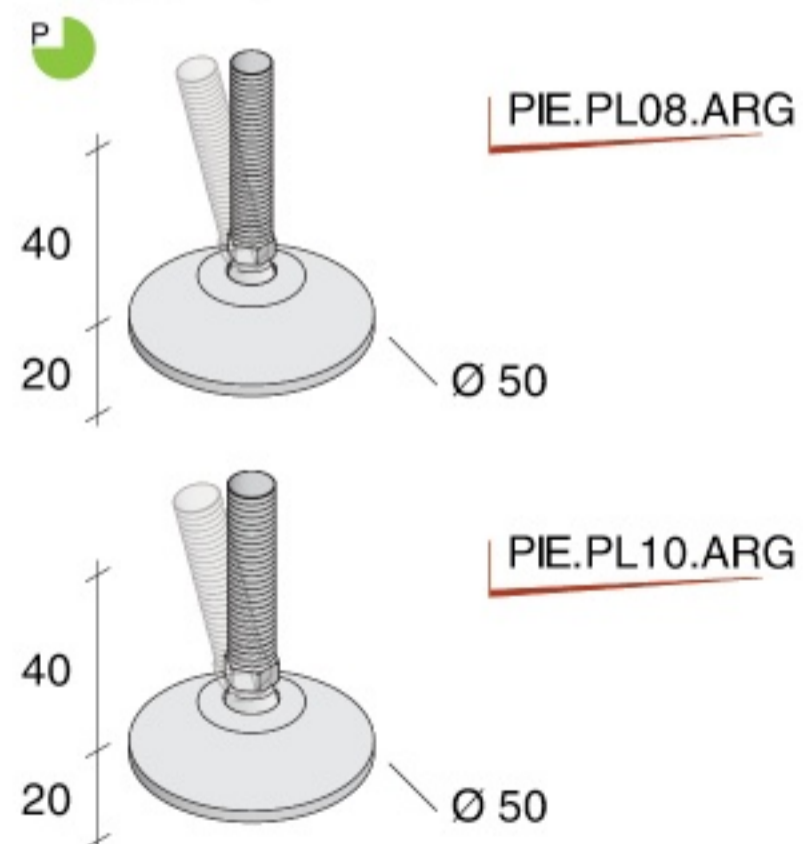

Aluminium foot with
passing hole for wall
fixing - **M8 and M10**

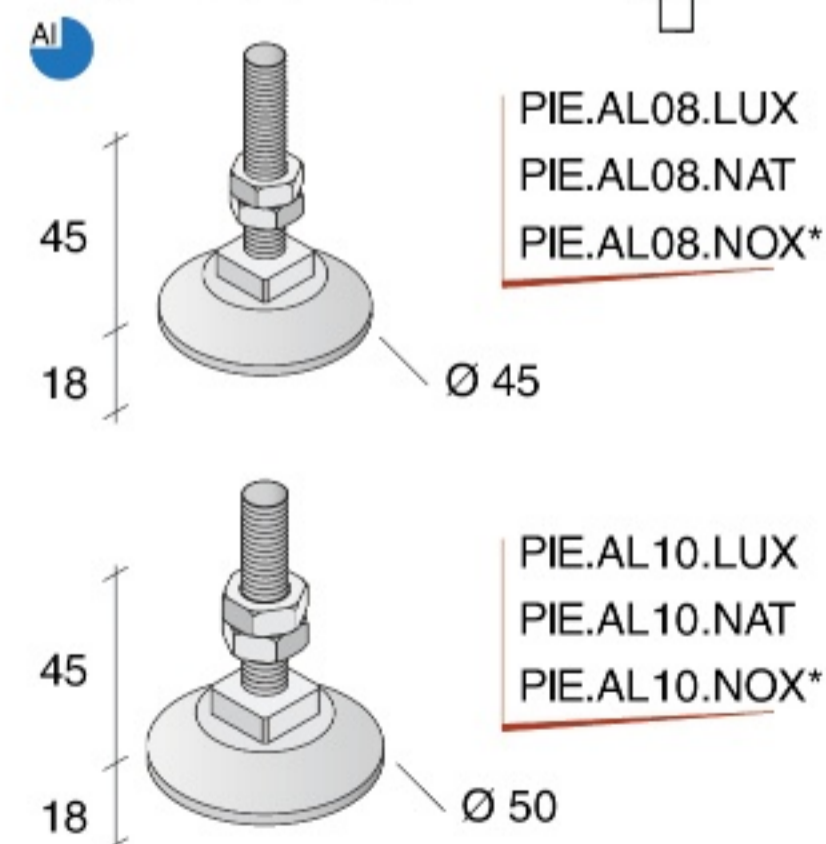

THREADED FERRULES

Self-locking nuts
for foot blocking to
ceiling (without IFM)



Threaded
ferrules

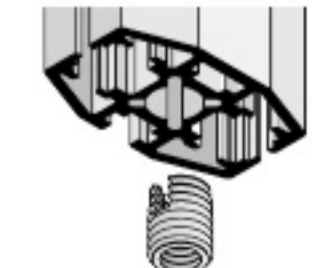

Assembly tools
for threaded
ferrules

