

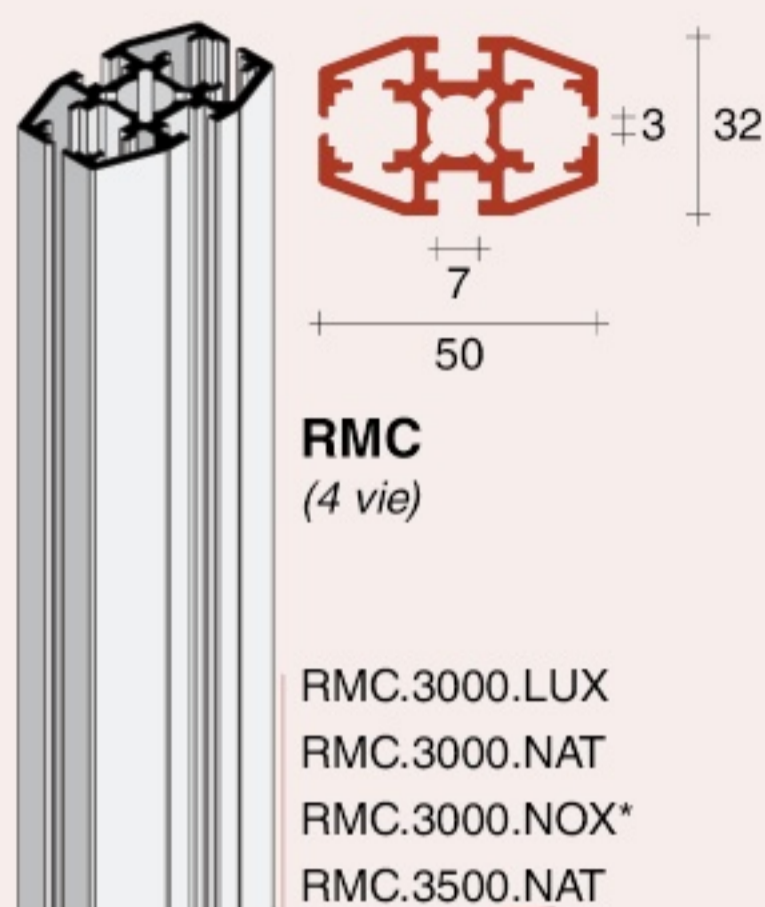

PROFILI AUTOPORTANTI RMC, RMS, RDC

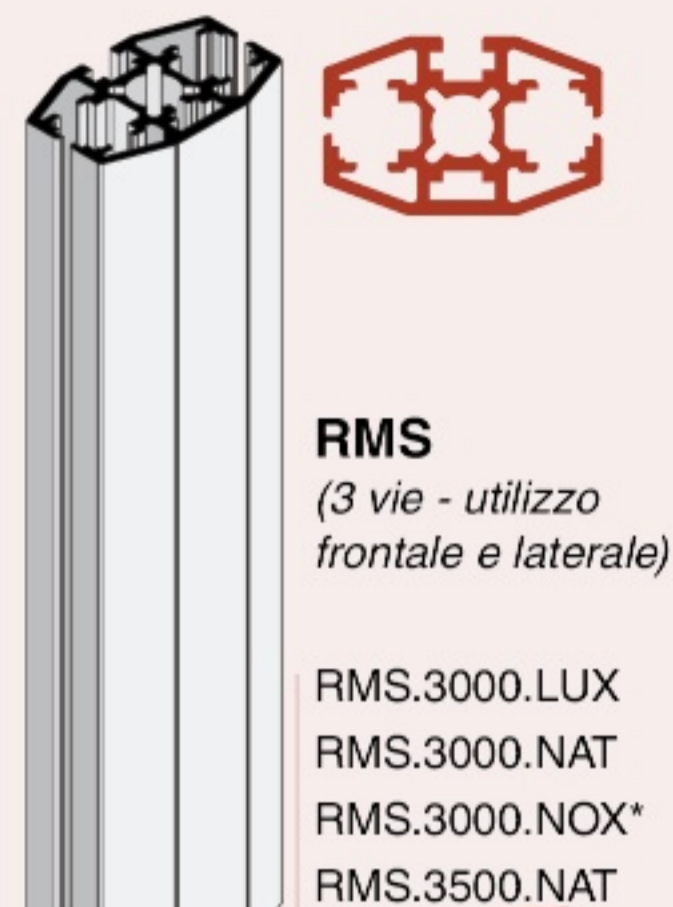

Compatibile con TCN e HLE



Compatibile con TCN e HLE

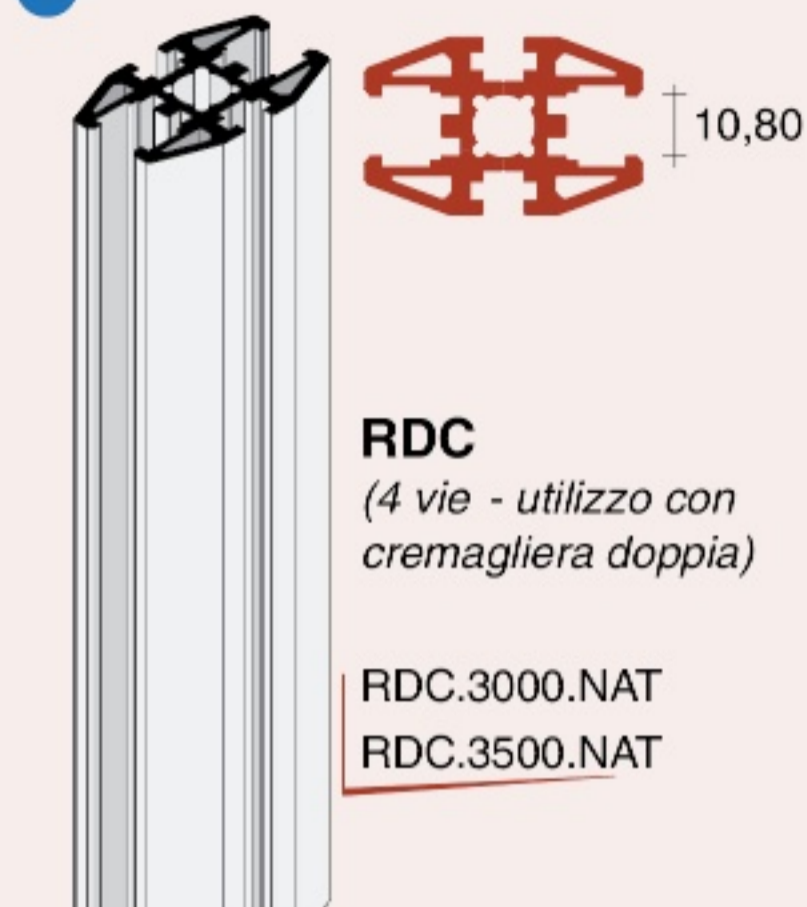

Compatibile con RD2 e HLE

CREMAGLIERE AD INSERIMENTO

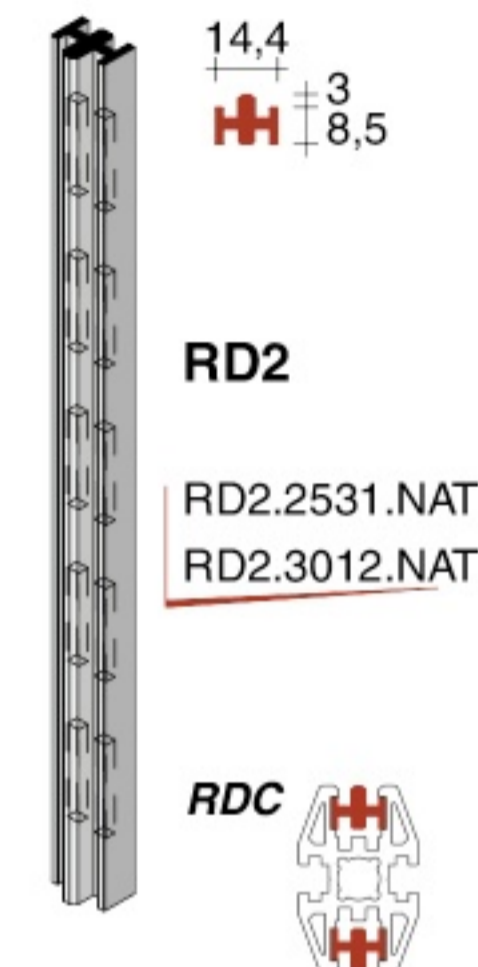
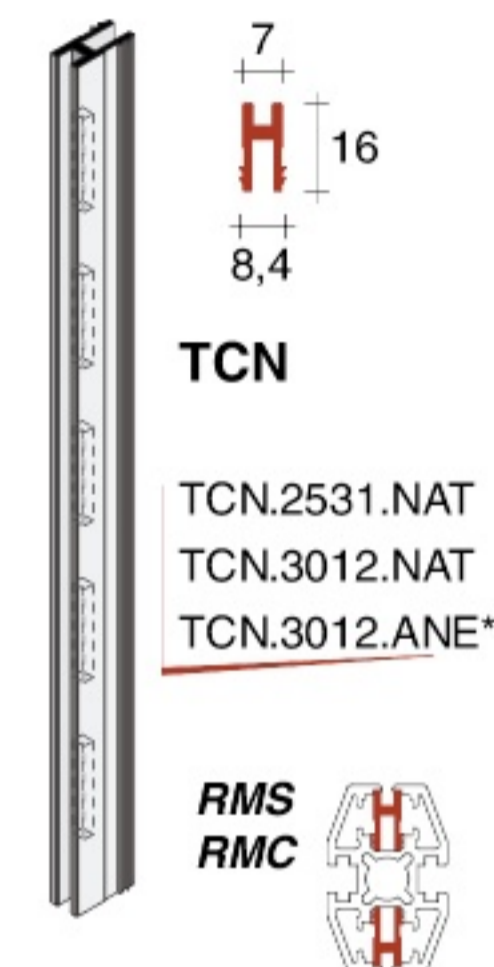

PIASTRA DI FISSAGGIO A MURO per RMC, RMS, RDC

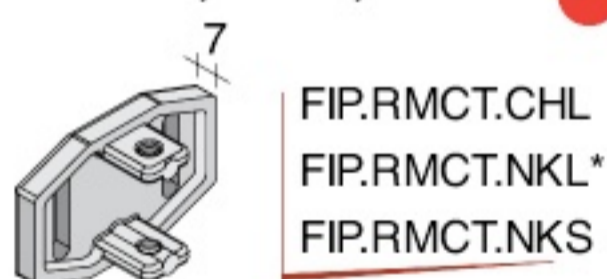

BASE FORATA per RMC, RMS, RDC



TAPPO DI FINITURA per RMC, RMS, RDC

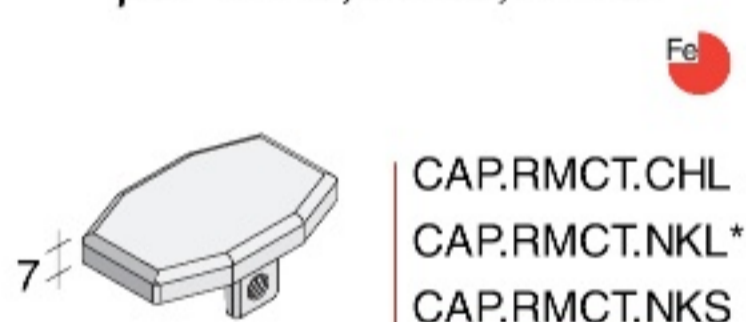

GUARNIZIONE per TCN e RD2

GRN.10MT.ARG

GRN.10MT.NER

INSERTI INTERNI per GIUNZIONI A 45°

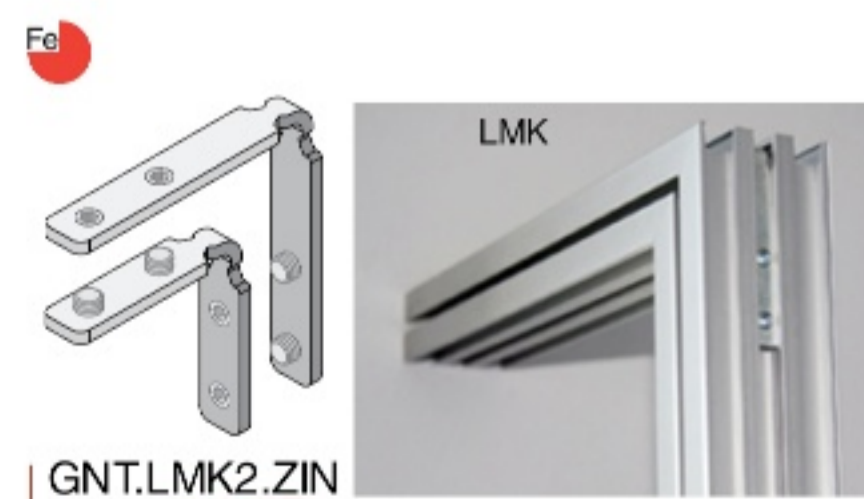
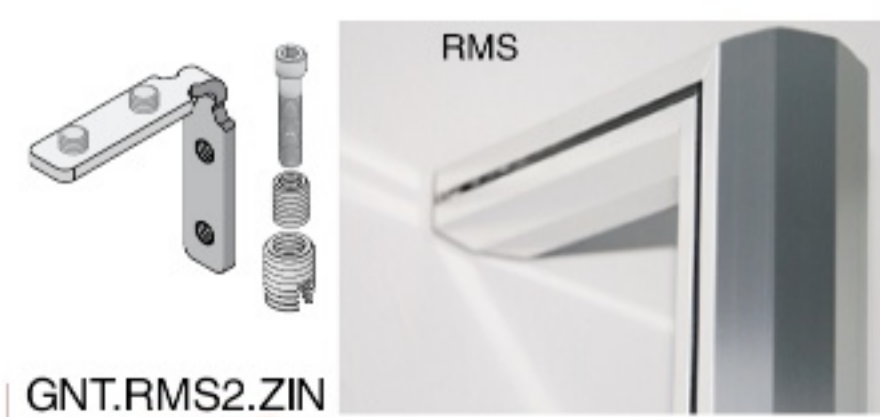

GIUNTO INTERNO





COMPOSIZIONI PAVIMENTO-PARETE con accessori CENTRALI su CREMAGLIERA

'BRAVO WALL45' - realizzate con RMS



'BRAVO WALL' - realizzate con RMS

