

# Serie RP

**PROFILI A CREMAGLIERA**  
Incastro a filo nella fresata di pannelli  
fino a 19 mm di spessore

## RP Series

**SLOTTED PROFILES**  
Insertion into milled panels up to 19 mm thick

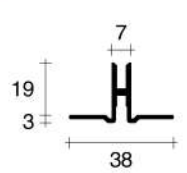
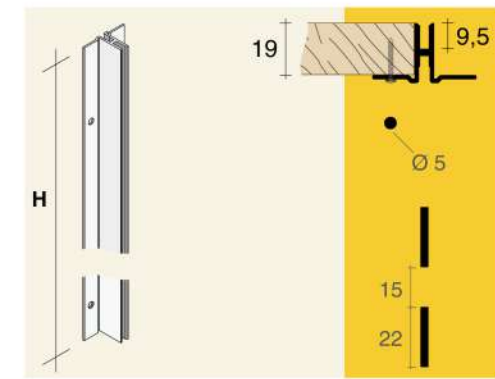

Codici Codes	AI	H
RP1.2013.	2013	2013
RP1.2531.	2531	2531
RP1.3012.	3012	3012



**RP1**  
singola  
single

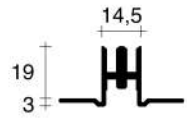

Codici Codes	AI	H
RP2.2013.	2013	2013
RP2.2531.	2531	2531
RP2.3012.	3012	3012



**RP2**  
doppia  
double

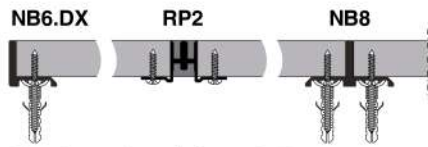

Vista in sezione della serie RP  
integrata con il sistema NB  
Section view of RP series combined  
with NB system profiles

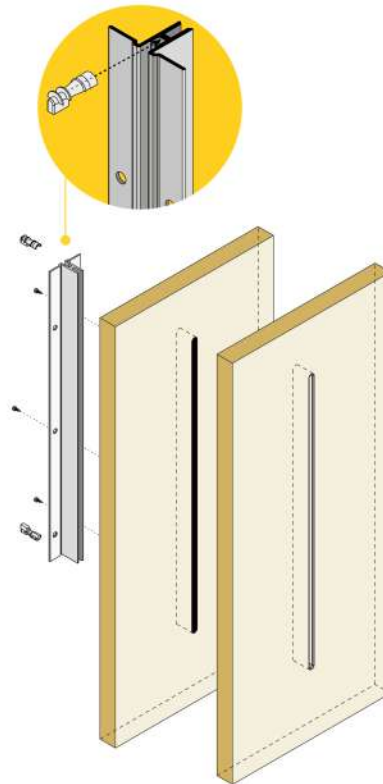

Tappo di finitura  
in fresata Ø 7,4 mm  
Frontal end cap  
on milling Ø 7,4 mm



- CAP.RP01.GRI
- CAP.RP01.NER
- CAP.RP01.NKS
- CAP.RP01.NKO\*

Tappo di finitura  
in fresata Ø 15 mm  
Frontal end cap  
on milling Ø 15 mm

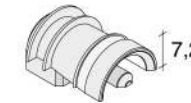

- CAP.RP02.GRI
- CAP.RP02.NER
- CAP.RP02.NKS
- CAP.RP02.NKO\*

Fresa elicoidale negativa  
per l'incasso del profilo RP1  
Helical end mill  
for RP1 profile insertion



utilizzare spessori di  
compensazione per  
montaggio a filo di  
pannelli sp. < 19 mm

use shim with  
panel < 19 mm thick,  
to fit flush

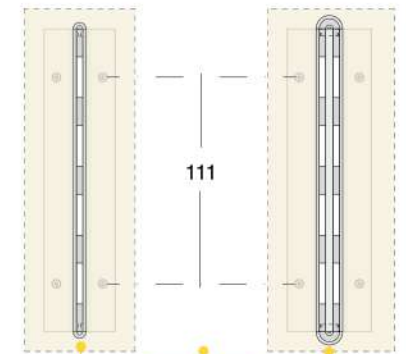
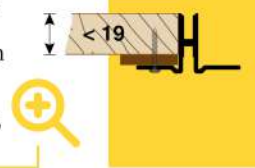

passo foratura Ø 5 mm  
per retro fissaggio  
drilling pitch Ø 5  
for rear mounting



Finiture Finishings	Alluminio Aluminium	AI
Argento satinato Satinized Silver	NAT	
Nero Black	ANE	
Superficie simil-acciaio inox Satinized Silver	SSO*	

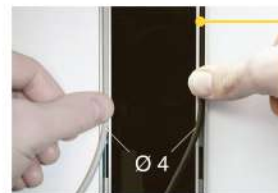

Guarnizione, Ø 4 mm  
Gasket, Ø 4 mm

- GRN.10MT.ARG Grigio Gray
- GRN.10MT.NER Nero Black
- GRN.10MT.BGE Bronzo Bronze

codice code  
XXX.XXXX.XXX\*

Asterisco = la finitura potrebbe non essere in pronta consegna.  
Asterisk = finishing not always ready in stock.

Finiture disponibili per profili H = 3012 mm  
Finishing available for profiles H = 3012 mm

Quote espresse in millimetri.  
Dimensions are in millimeters.

Accessori correlati  
Related accessories

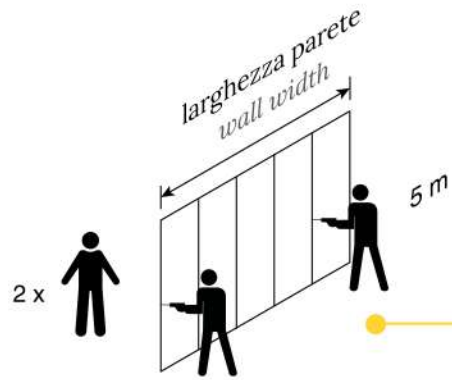

**Sistema NB**  
NB System

19 9,5

**Cremagliere NB**  
Nb Slotted profiles

**Rivestimento NB0**  
NB0 wall cladding

1 h 30'

2 h 30'

**PK**

10 6

6 h

**CG**

13

8 h

**CR**

8 1

6 h

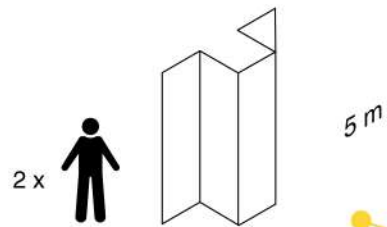

**Angolo con NB9**  
Angle with NB9

**Rivestimento NB0**  
NB0 wall cladding

3 h

5 h

**PK-R19**

10

-

-

**Angolo con CR0**  
Angle with CR0

8 h

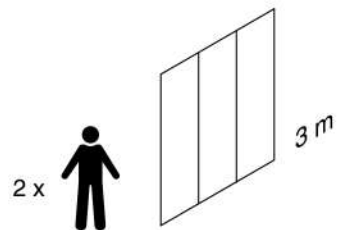

**Cremagliere NB**  
Nb Slotted profiles

**Rivestimento NB0**  
NB0 wall cladding

1 h

2 h

4 h

5 h

4 h

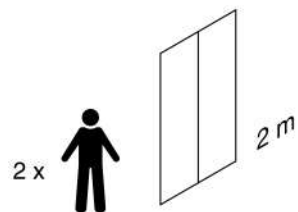

**Cremagliere NB**  
Nb Slotted profiles

**Rivestimento NB0**  
NB0 wall cladding

45 min

1 h 30'

3 h

4 h

3 h 30'

# Note tecniche

## Technical data

### CAPACITÀ DI CARICO

#### LOADING CAPACITY

Durante l'utilizzo di profili porta-piani in alluminio **si tengano presenti i seguenti fattori:**

- **STRATEGIA DI PRODUZIONE:** la progettazione di ogni profilo, la scelta della lega e le fasi di produzione sono integrate per ottenere da ciascuno di essi la qualità e la tenuta stabilite. La mancanza di questo accorgimento è la ragione per cui le riproduzioni dei nostri prodotti non hanno le necessarie caratteristiche di portata.
- **FISSAGGIO:** i profili sono realizzati per superare la tenuta del tassello a muro (mediamente 350 kg in condizioni ottimali), quindi è fondamentale che l'ancoraggio a parete sia opportunamente eseguito, anche per mezzo di telai quando necessario.
- **PROGETTAZIONE DELLE AMBIENTAZIONI:** le indicazioni di questo catalogo e la professionalità dell'installatore o del progettista, determinano la selezione del giusto profilo e della sua applicazione, secondo le finalità. Sono disponibili svariate opzioni: tipo di foratura - singola o doppia - e montaggio, asse centrale o laterale, distanze ed interassi ed i loro conseguenti accessori.

**Keep in mind these factors** during the use of aluminium profiles:

- **PRODUCTION STRATEGY:** The design of the different profile sections are decided in relation with the alloy choice and the manufacturing processes. It allows each item to reach the reference loading capacity. This is the main reason why replicated products, found sometimes in the market, do not reach the FitArt loading capacity characteristics.
- **FIXING:** Profiles are conceived in order to exceed the loading capacity of a 5 mm wall plug that reaches in average around 350 kg under normal operating conditions. It is very important to carry out the most suitable fixing to the wall, also using frames if necessary.
- **PLANNING AND DESIGN OF THE STRUCTURE:** The indications of this catalogue and the professional experience of a designer or an installer determine the choice of a right profile and its application. The different profiles options are available regarding: drilling types -single or double- and assembly, central or side load, distances and spans between profiles, and its related accessories.

### PROVE DI CARICO

#### LOADING TESTS

I nostri profili a cremagliera sono sottoposti a severe **prove distruttive con simulazioni in laboratorio.**

Le immagini e il grafico qui riprodotti mostrano un nostro profilo standard, caricato su un singolo dente, resistere fin oltre 400 kg.

Our slotted profiles are subjected to very severe **destructive tests in laboratory simulations.**

The test here described shows a standard profile, with support loaded on a single tooth, standing over 400 kg.

### Compressione cremagliera murale NB1

#### NB1 Wall slotted profile compression

TABELLA  
DI DEFAULT  
DEFAULT  
TABLE

Modo di controllo 1  
Velocità 1  
Corsa 1  
5 mm/min  
  
Control 1  
Speed 1  
Run 1  
5 mm/min

Risultati  
Results

	Etichetta provino Label test	Carico compressione Compression load
1	<b>T.01</b>	<b>&gt; 438,819 [daN]</b>

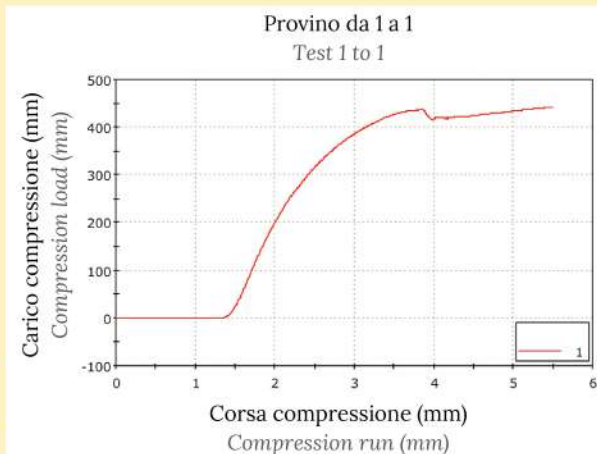

Sezione  
cremagliera  
Profile  
section

Supporto  
caricato  
Support  
loaded

Provino  
Test

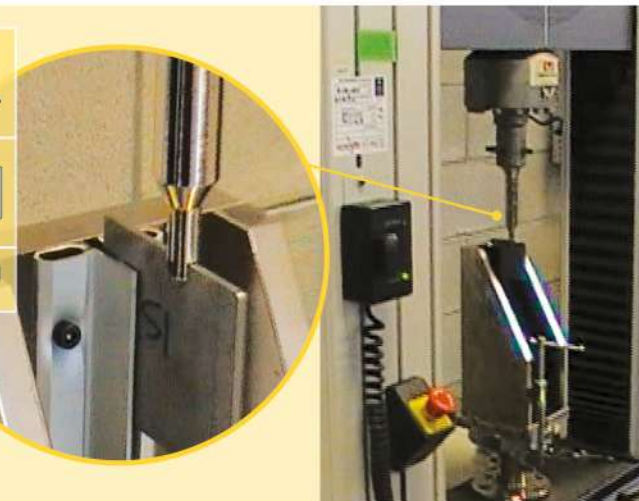
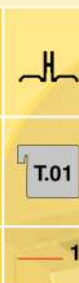

Decliniamo ogni responsabilità per l'utilizzo dei nostri profili con supporti non di nostra produzione, e viceversa, in particolare se prodotti in acciaio inossidabile.

Fit Art disclaims any responsibility for the use of our profiles with supports not of our production, and vice versa, especially the ones realized in stainless steel.



### SOLLECITAZIONI AL CARICO

LOADING REACTION

Un carico puntuale su un profilo a cremagliera produce gli stessi effetti di una leva di primo genere (palanchino): **aumentando la distanza dal fulcro (braccio della leva) aumenta proporzionalmente l'effetto della leva.**

The effect of a localized load on a slotted profile is similar to the action of a force applied to a lever (such as a crowbar): **with an increase of the distance (lever arm) from the fulcrum, the lever increases proportionally.**

### Ipotesi di comportamento lineare

Hypothesis of linear behaviour

Carico interno al supporto  
Inside support load

kg	cm
60	10
30	20
20	30

STESSO EFFETTO DI SOLLECITAZIONE  
SAME STRESS EFFECT

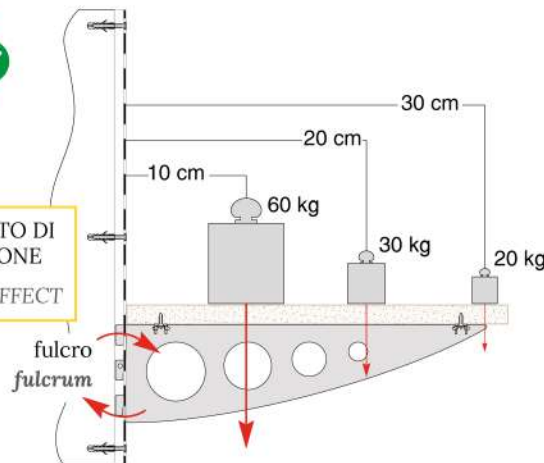

### Carichi a sbalzo: comportamento non lineare

Overhang load: no more valid linear behaviour

Carico a sbalzo  
Overhang load

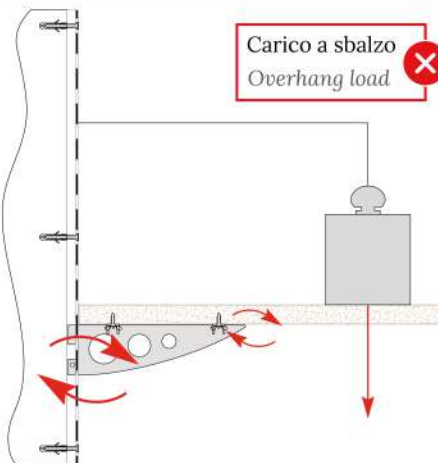

### CATEGORIE DI PORTATA

LOADING CATEGORIES

Poiché dai dati tecnici finora considerati **non si può assegnare alcuna portata nominale.**

A titolo puramente indicativo abbiamo suddiviso i profili in categorie di portata subordinate alle **sezioni** ed alla **disposizioni degli ancoraggi.**

According to the technical data provided in these pages, it becomes very difficult to assign a nominal loading capacity in average conditions.

Anyway the profiles can be divided into the following loading categories, considering the **section dimension** and how the **fixings are positioned.**



**ALTA**  
HIGH

- Profili**
- con fissaggi doppi
  - con tanti punti di ancoraggio
  - inseriti all'interno di montanti
- Profiles**
- with double fixings
  - with many anchor points
  - inserted into the uprights

NB1 / NB2  
LMK + HLE  
CG1 / CG2  
PK1 / PK2  
RMC + TCN  
RP1 / RP2  
RDC + RD2  
FDC + RD2



**MEDIA**  
MEDIUM

- Profili**
- con fissaggi doppi con passo maggiore di 20 cm
  - con fissaggi su un lato a meno di 20 cm di distanza
- Profiles**
- with double fixings with more than 20 cm pitch
  - with single side fixings at less than 20 cm distance

NB7 / NB3  
CR1 / CR2  
CG7 / PK7



**BASSA**  
LOW

- Profili**
- con fissaggi su un lato con passo maggiore di 20 cm
  - CONCEPITI PER INCASSO con sezioni contenute
- Profiles**
- with single side fixings at more than 20 cm
  - profiles with restrained section  
CONCEIVED TO BE EMBEDDED

CR7  
serie ad  
incasso  
  
CR7  
embedded  
series

Quote espresse in millimetri.  
Dimensions are in millimeters.

Accessori correlati  
Related accessories