

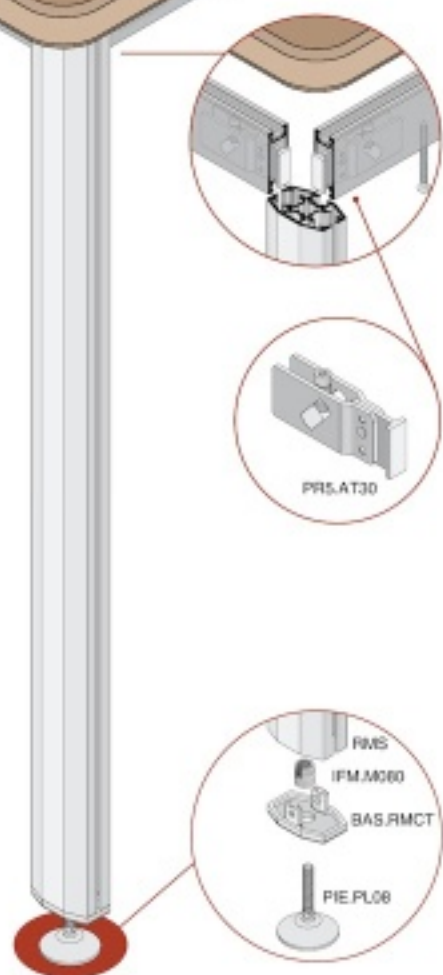

OTHER
COMPOSITIONS

'TAVOLO' - realized with RMS





EQUIPPABLE GONDOLAS with INTERNAL DIVIDING PANELS

'ISOLA' - realized with LMK

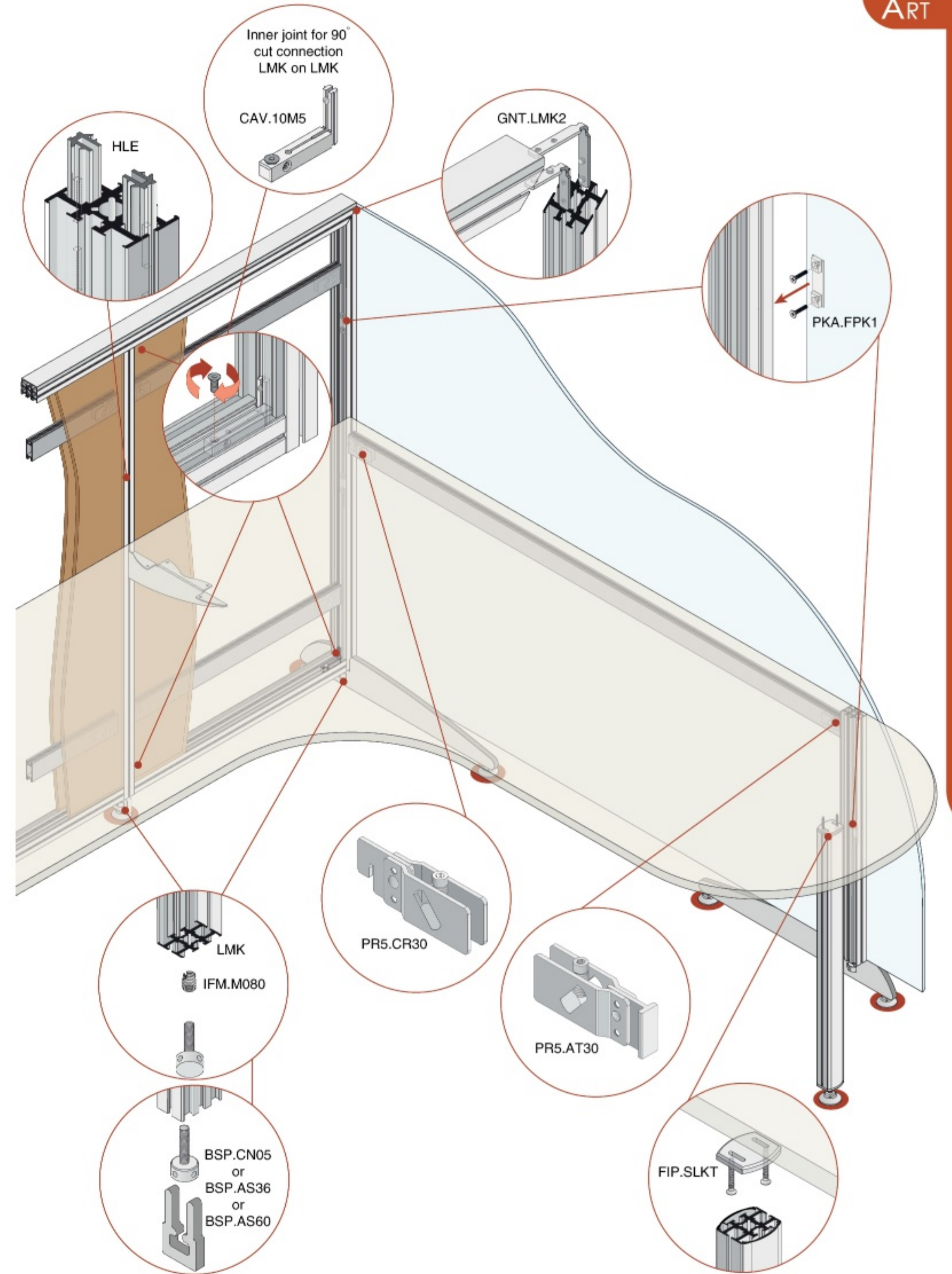



FLOOR - WALL COMPOSITIONS with CENTRAL accessories on SLOTTED PROFILE

'SQUARE WALL45'

LMK with SCK



'ONDA WALL45'

LMK with SLK





FLOOR - WALL expansion COMPOSITIONS with CENTRAL accessories on SLOTTED PROFILE

'BRAVO WALL45' - realized with RMS



'BRAVO WALL' - realized with RMS

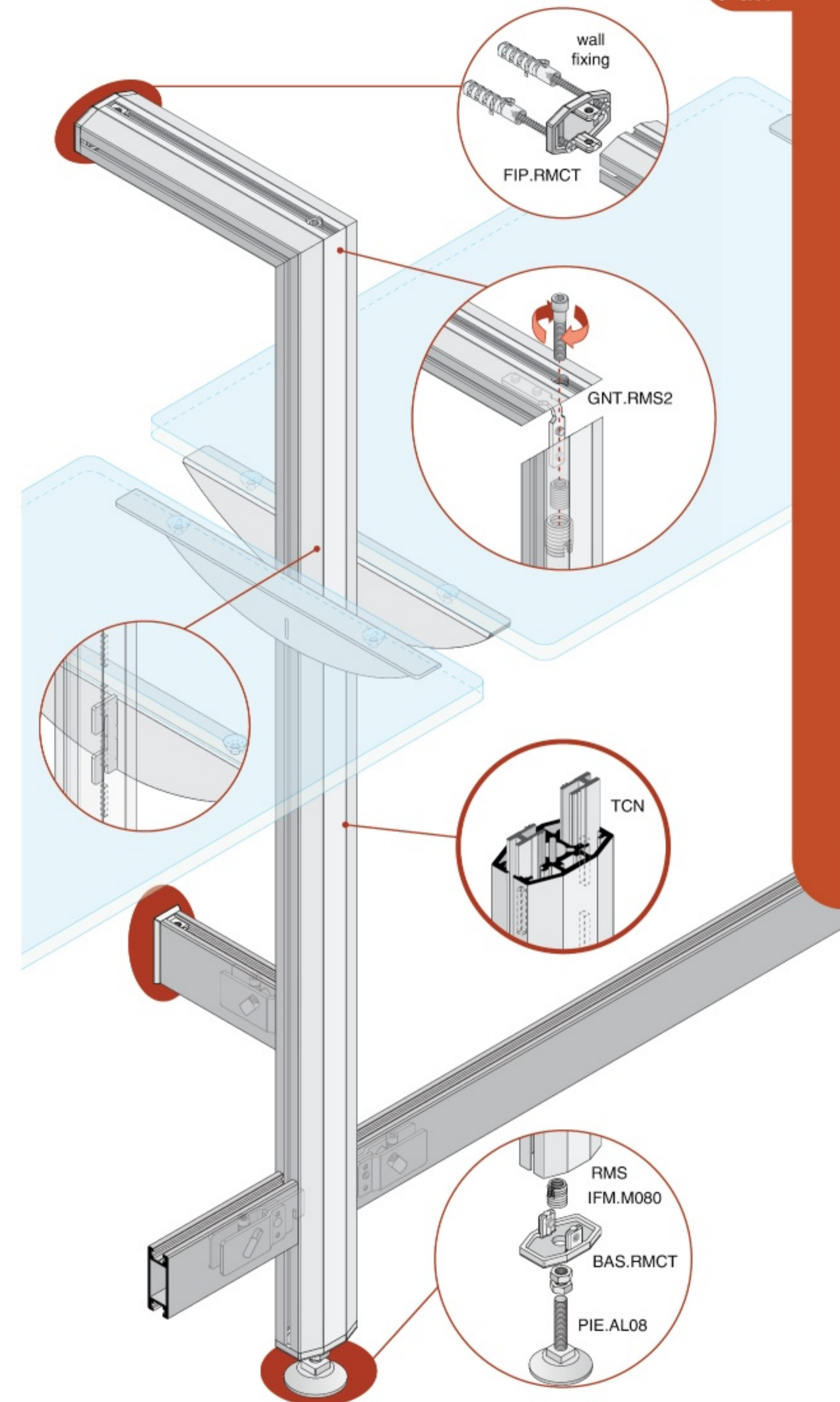



FLOOR - WALL expansion COMPOSITIONS with CENTRAL accessories on SLOTTED PROFILE

'ALPHA HLE WALL45' - realized with RMC and RMS



HLE - TR5 - PR5.AT30



BSP.AS36 - PIE.AL08

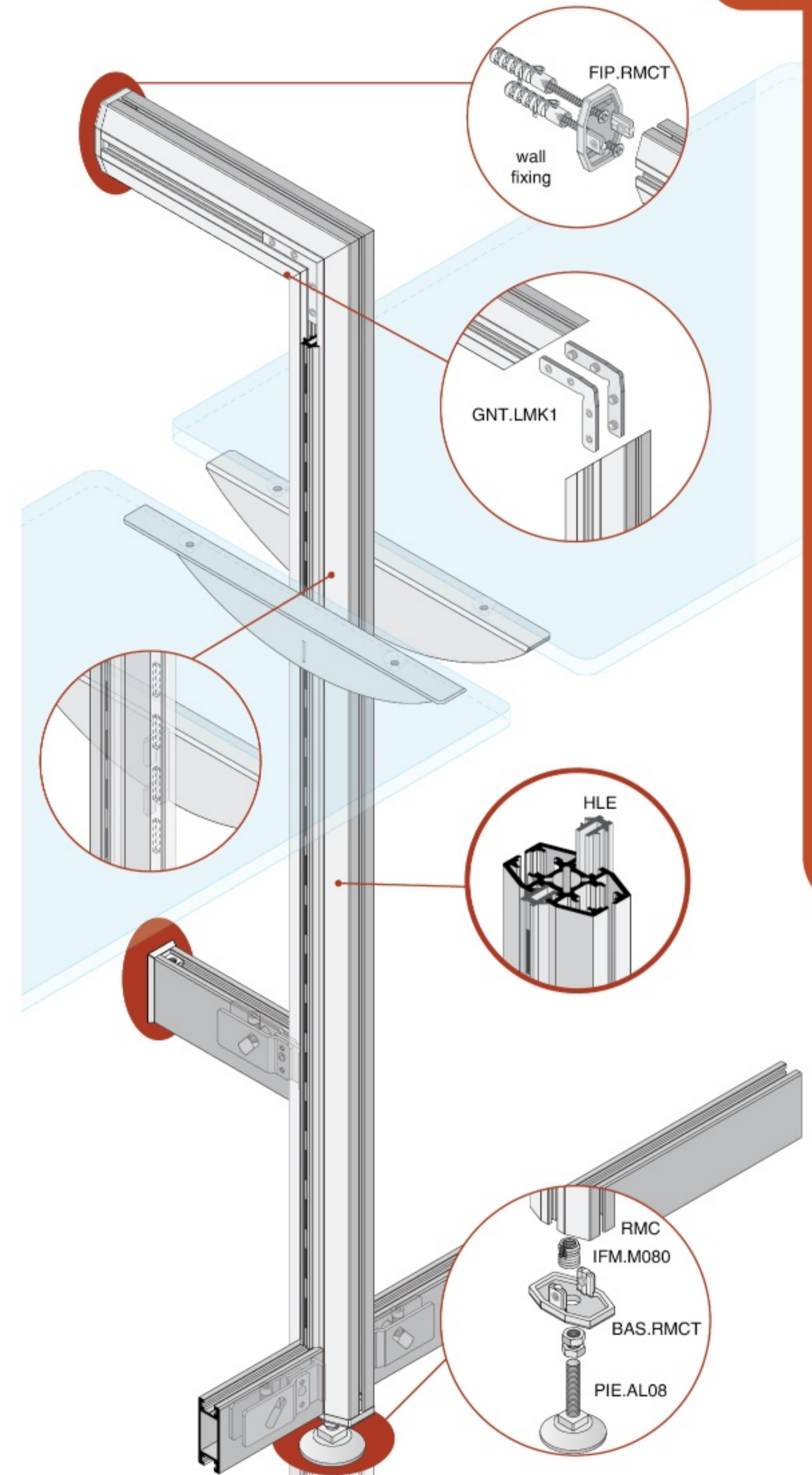



FLOOR - WALL expansion COMPOSITIONS with CENTRAL accessories on CAM

'ALPHA WALL45' - realized with RMC and RMS

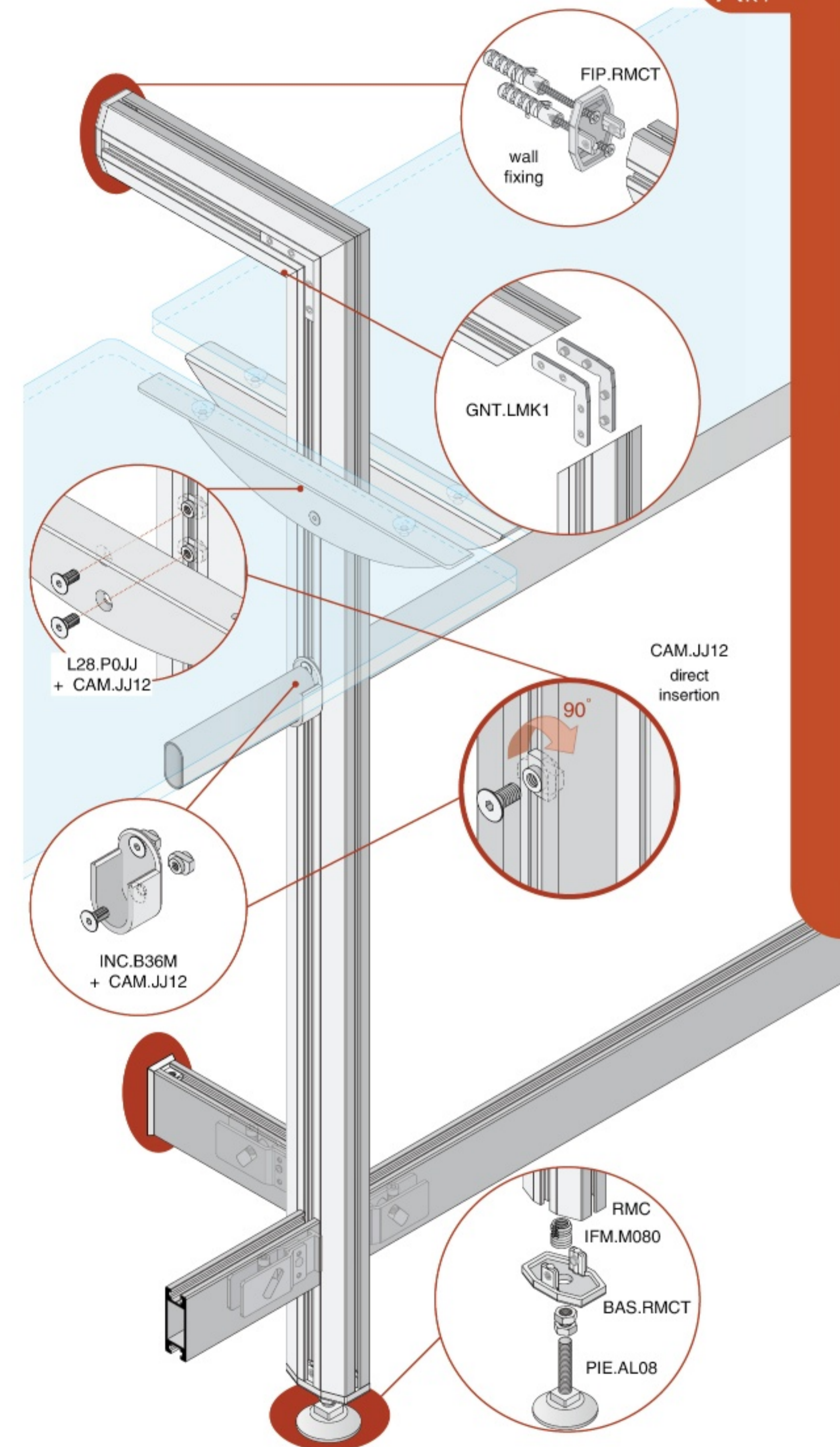
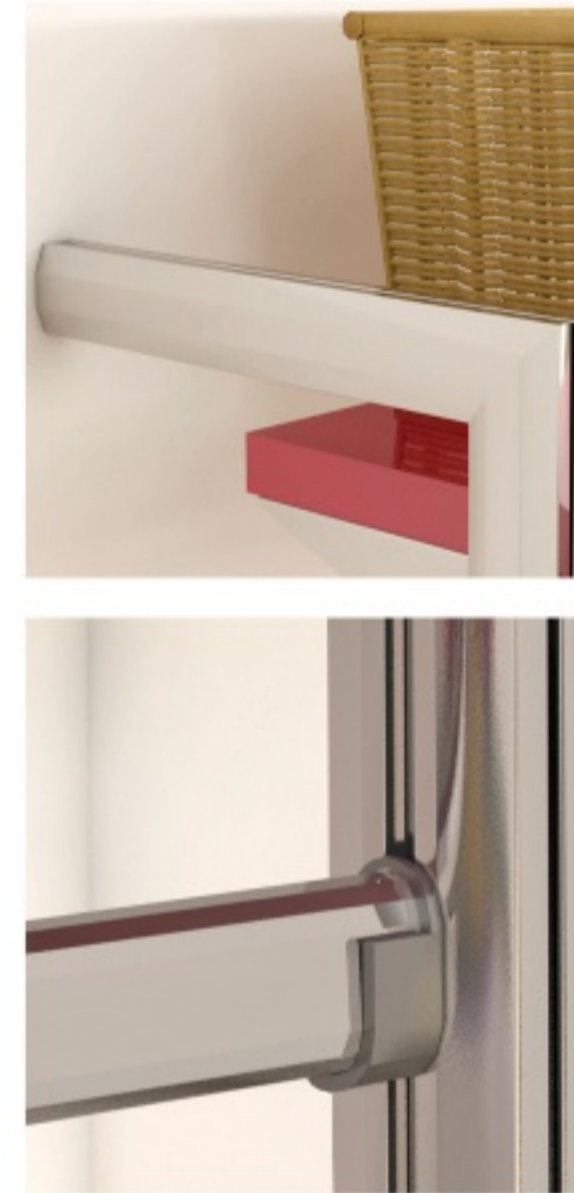

BASES WITH THREADED FERRULE M8

L = length

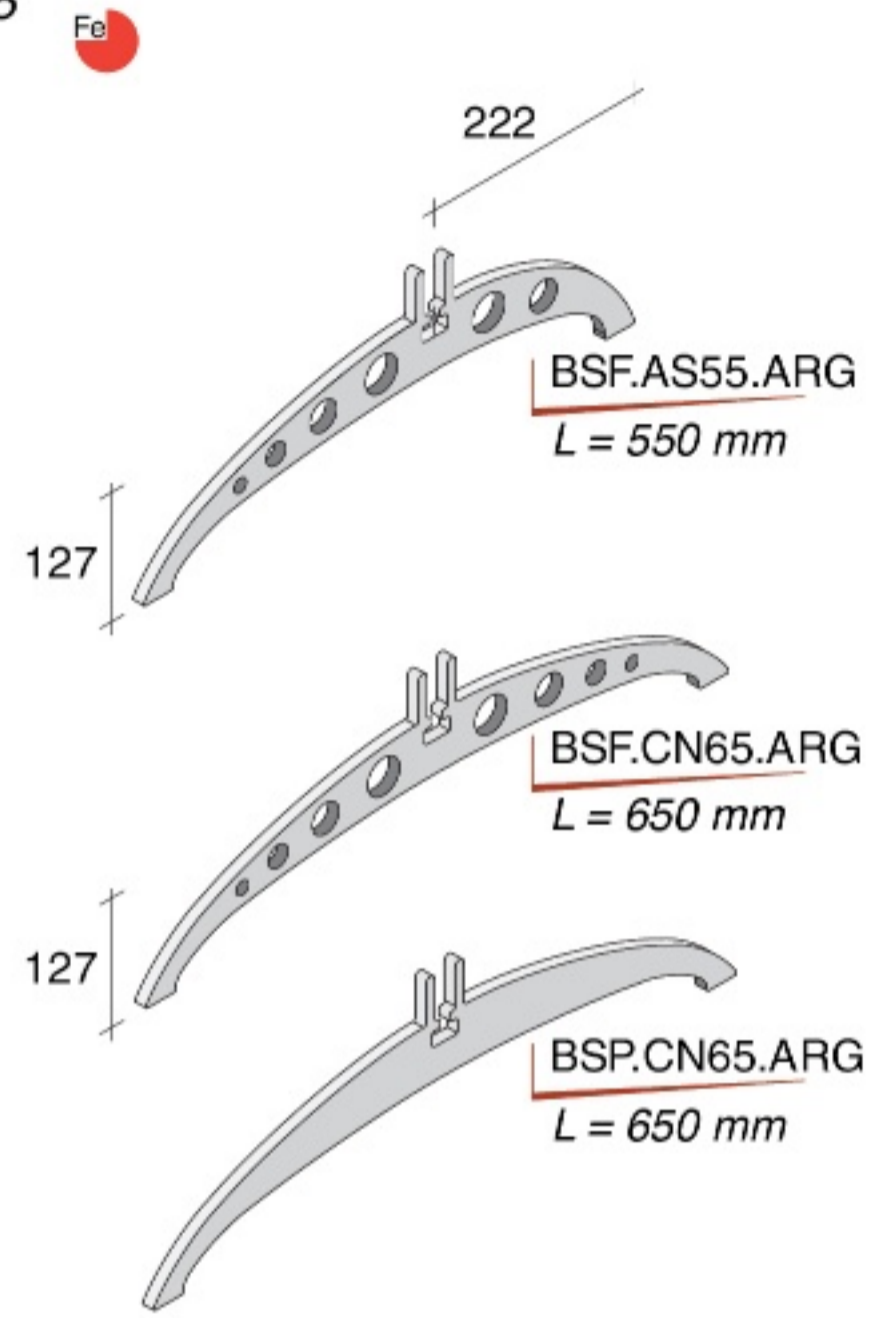
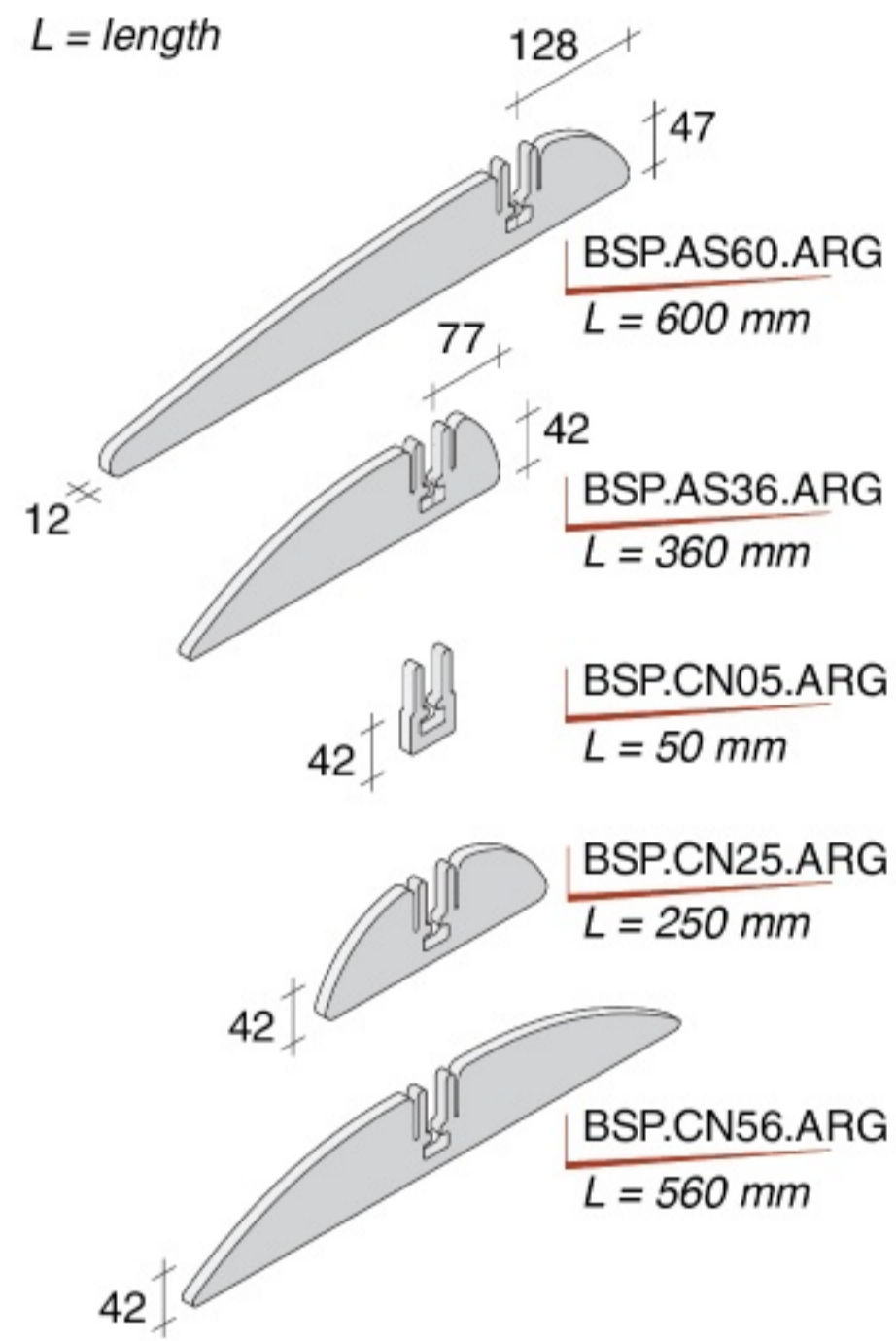

Support plate for
SLK and SCK coverings

BAS.HCOP.ZIN

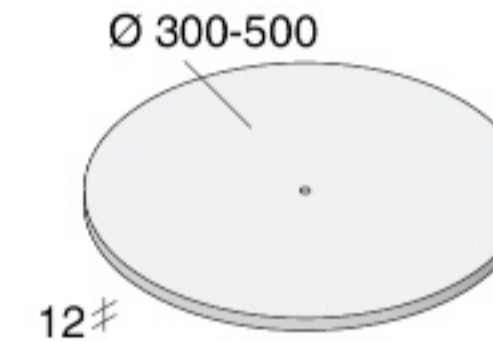
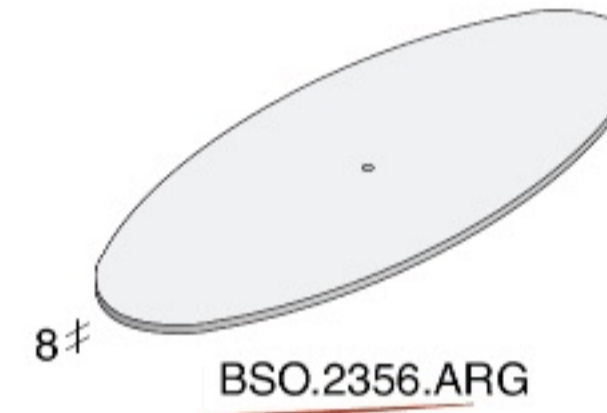
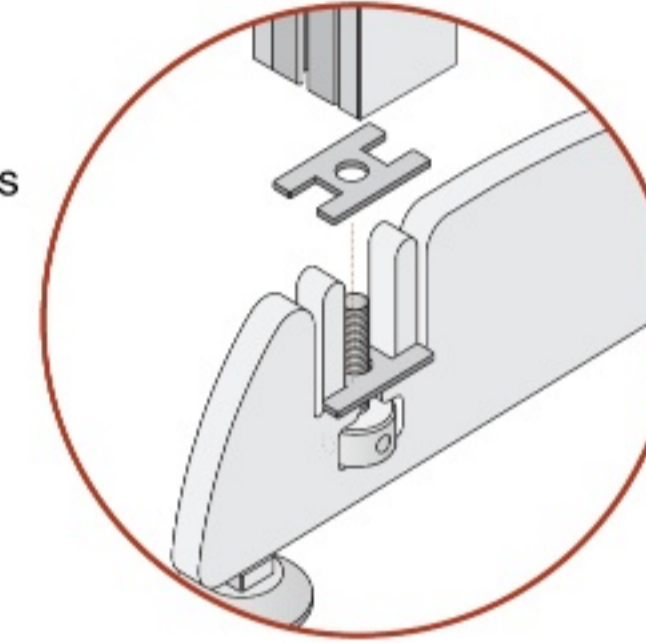

BST.D300.ARG+
BST.D350.ARG+
BST.D400.ARG+
BST.D450.ARG+
BST.D500.ARG+



PIE.AL10.LUX



BSP.CN65.ARG with PIE.AL08.NAT

FEET

Plastic
tilting foot
M8 and M10

UNSUITABLE
for ceiling-floor
application

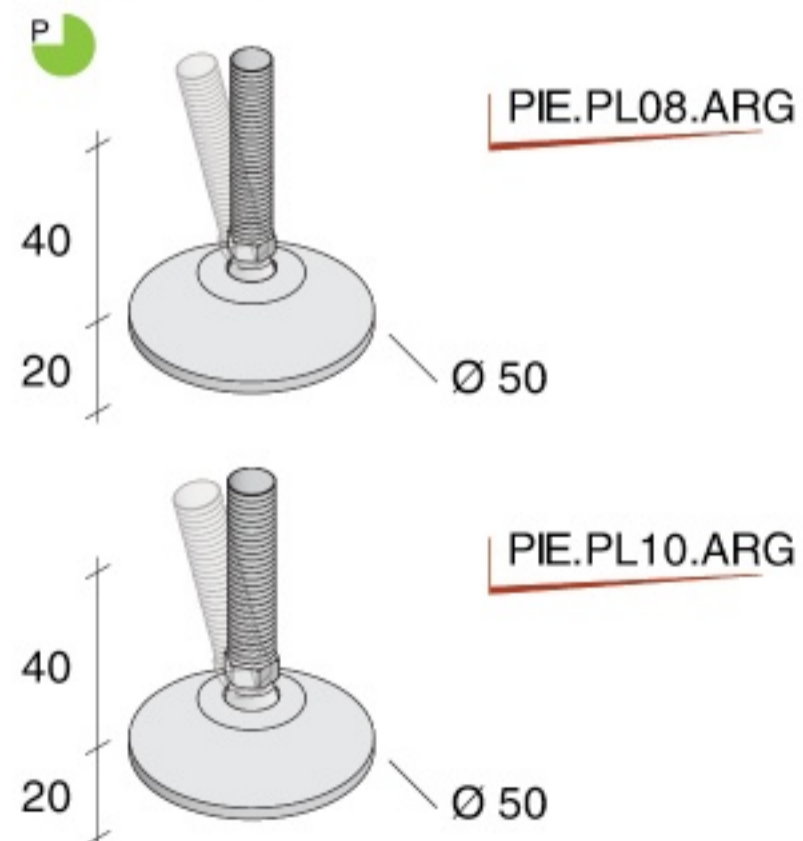

Aluminium foot with
passing hole for wall
fixing - **M8 and M10**

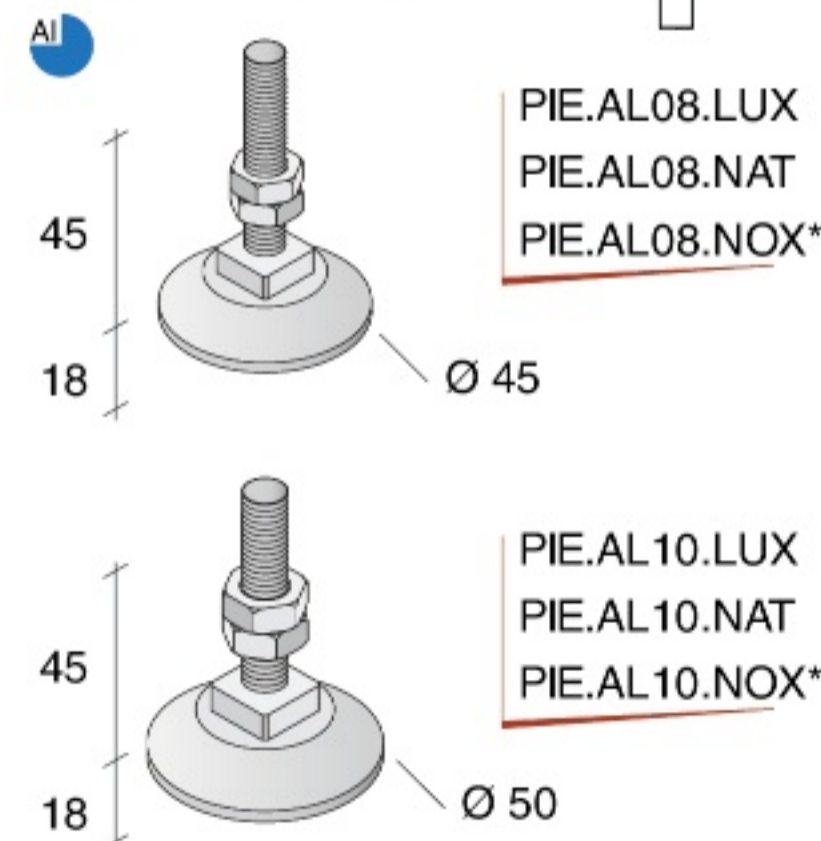

THREADED FERRULES

Self-locking nuts
for foot blocking to
ceiling (without IFM)



Threaded
ferrules

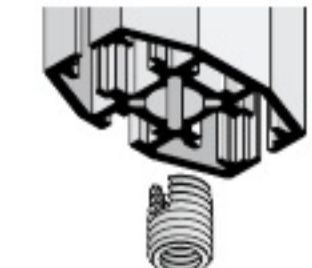

Assembly tools
for threaded
ferrules



BSP.AS60.ARG with PIE.AL08.NAT