

## BASES WITH THREADED FERRULE M8

L = length

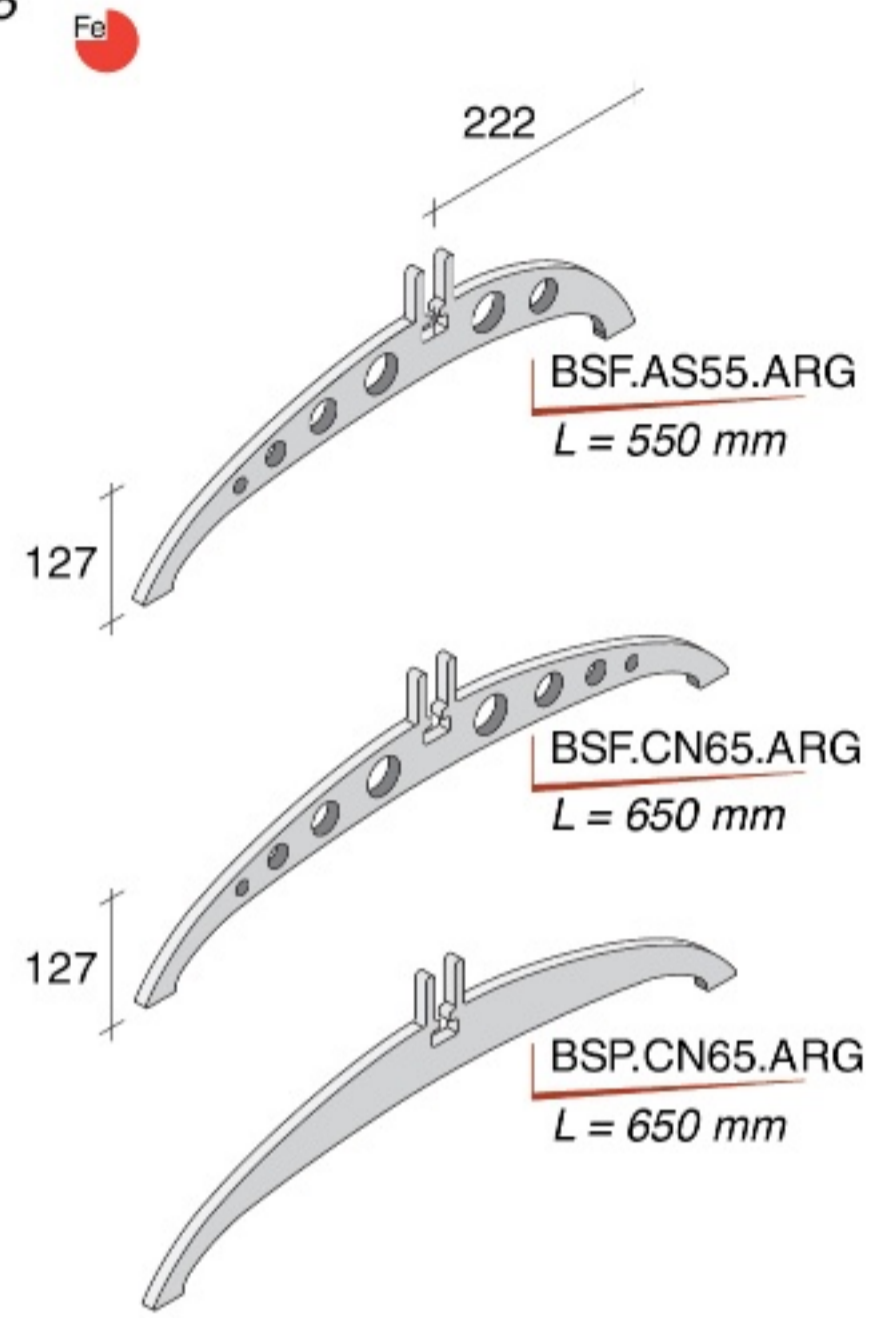
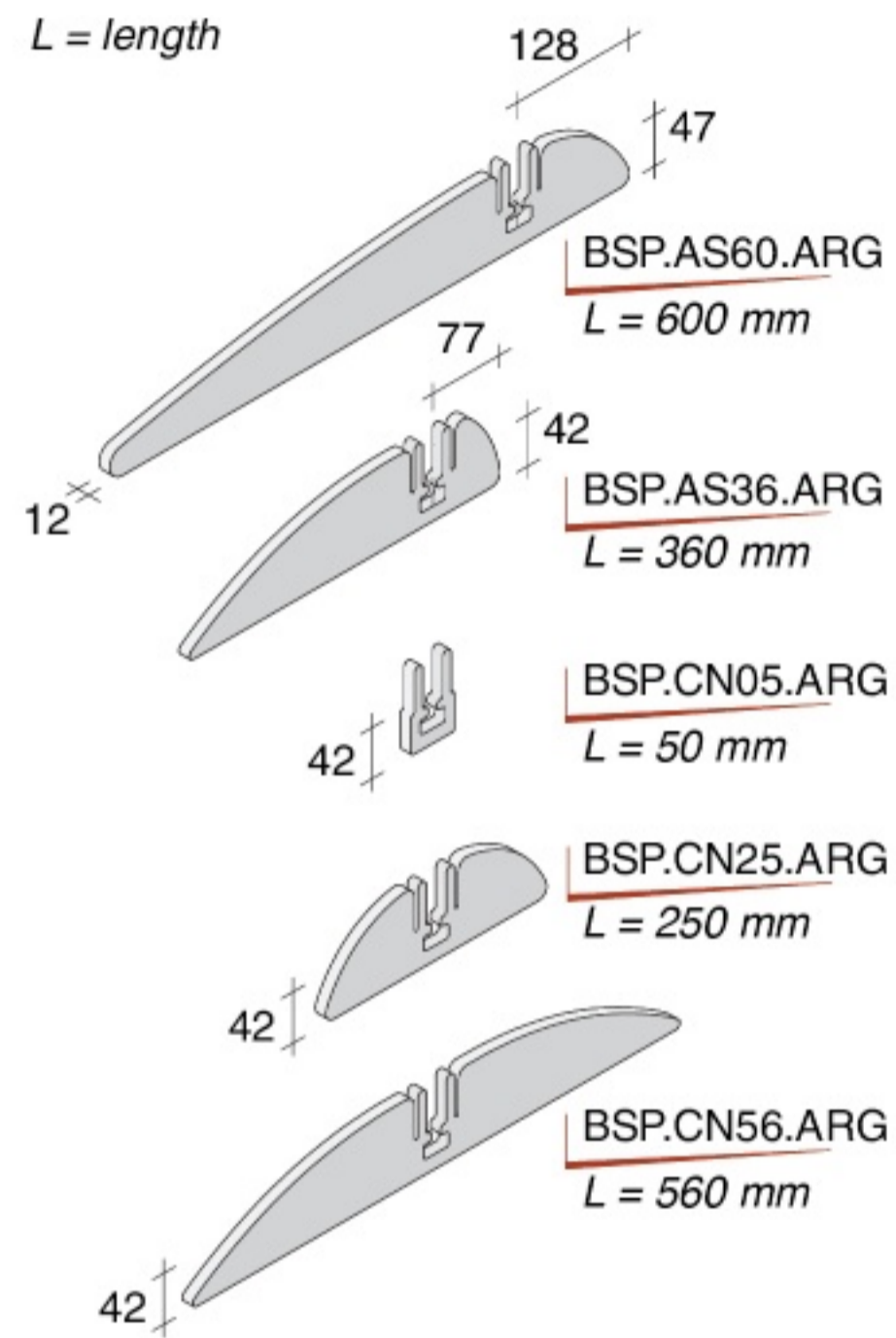

Support plate for SLK and SCK coverings

**BAS.HCOP.ZIN**

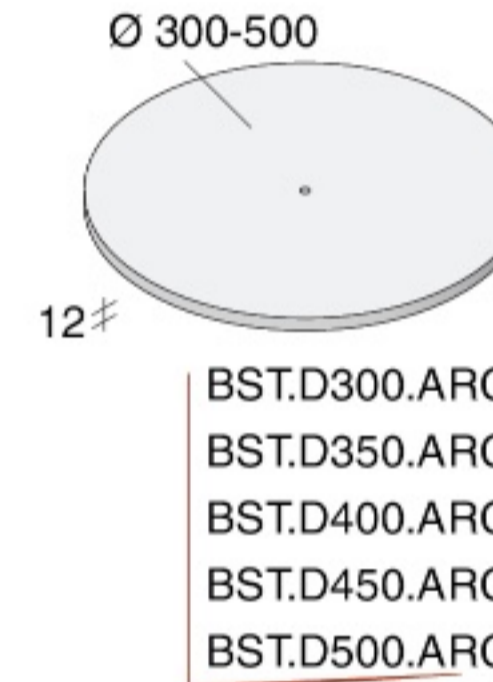
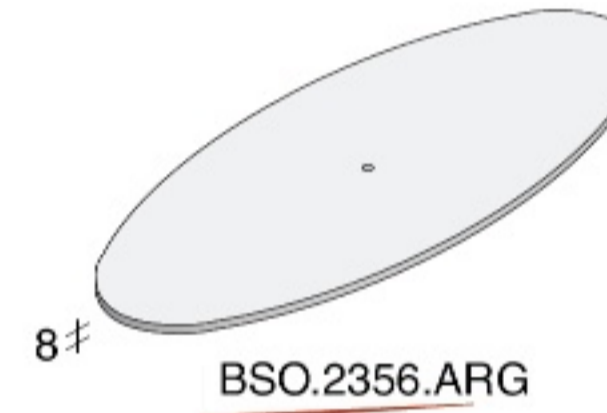
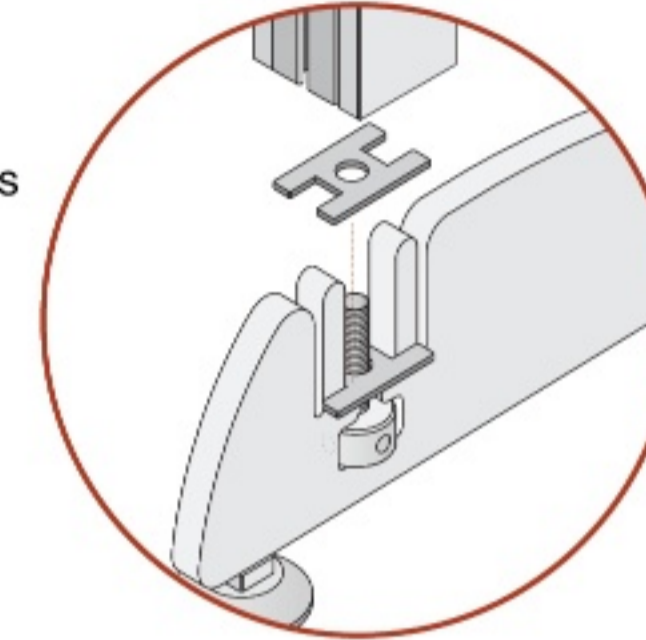

PIE.AL10.LUX



BSP.CN65.ARG with PIE.AL08.NAT



BSP.AS60.ARG with PIE.AL08.NAT

## FEET

Plastic tilting foot  
**M8 and M10**

**UNSUITABLE**  
for ceiling-floor  
application

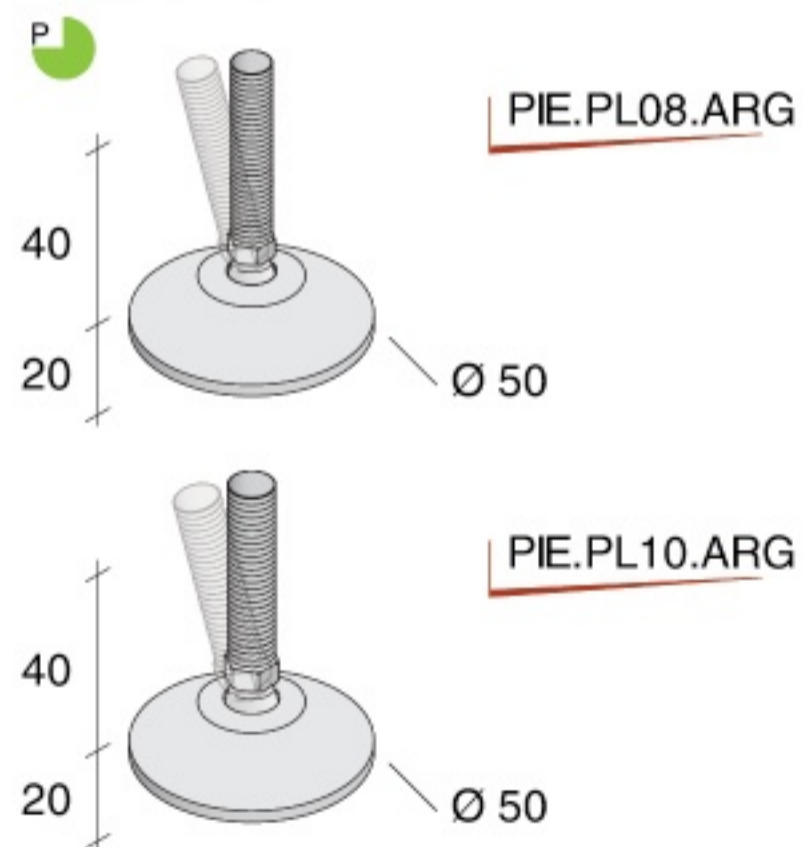

Aluminium foot with  
passing hole for wall  
fixing - **M8 and M10**

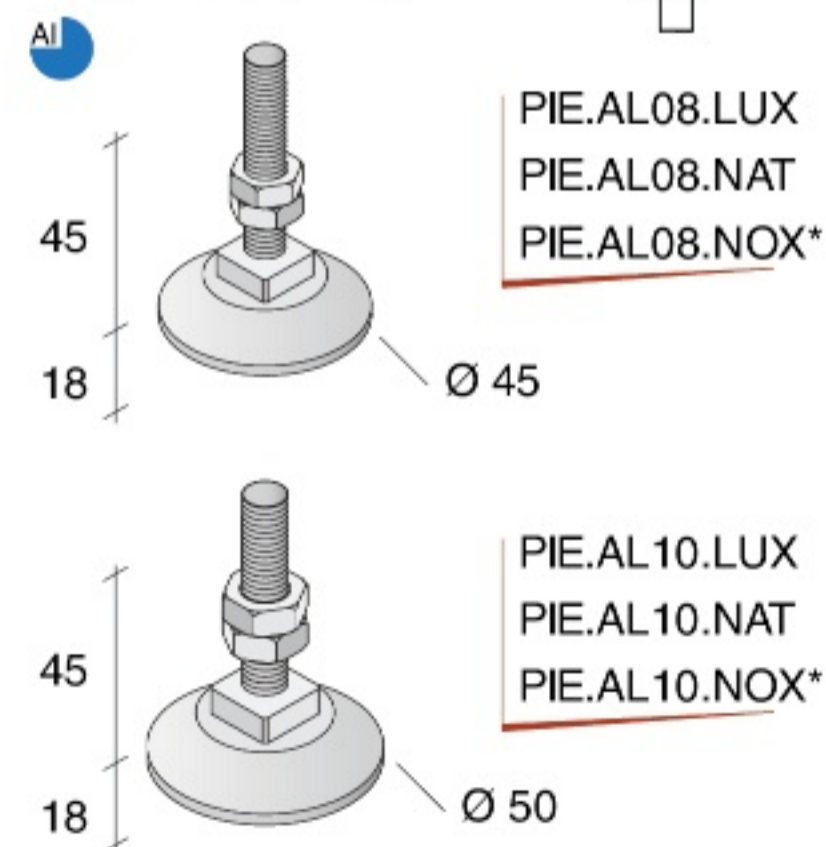

## THREADED FERRULES

Self-locking nuts  
for foot blocking to  
ceiling (without IFM)



Threaded  
ferrules



Assembly tools  
for threaded  
ferrules

