

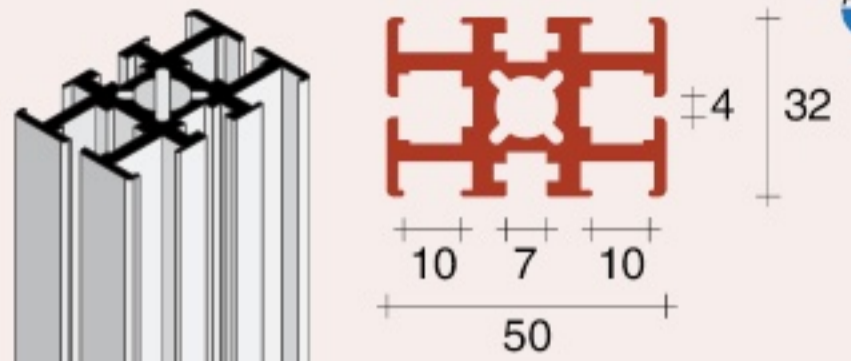

LMK PROFILO MULTIFUNZIONE



LMK
(4 vie - utilizzo frontale e laterale)

- LMK.1500.NAT
- LMK.2000.NAT
- LMK.2500.NAT
- LMK.3000.NAT
- LMK.3500.NAT

Compatibile con HLE

PROFILI DI COPERTURA

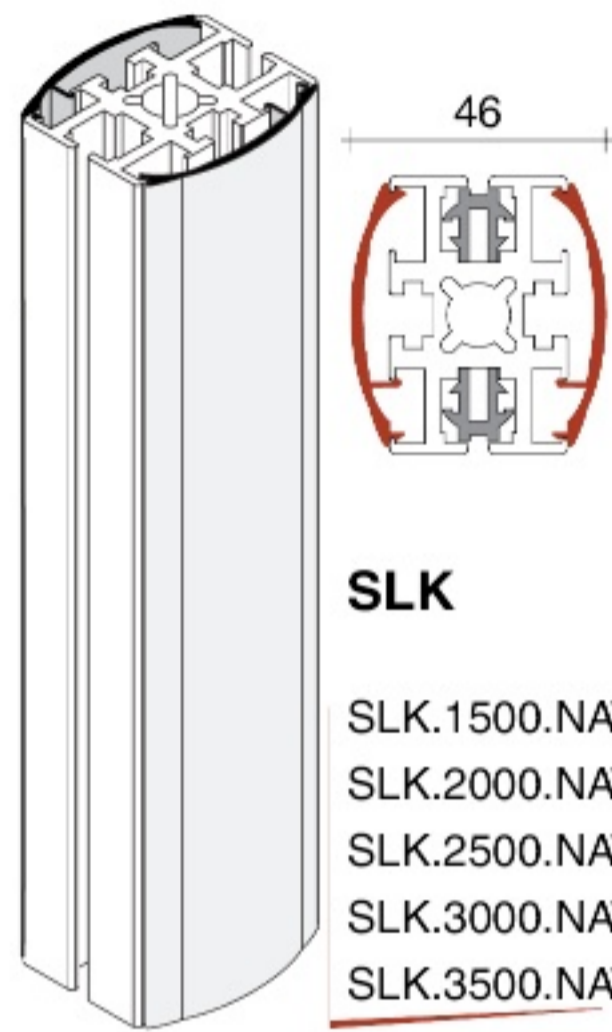

SLK

- SLK.1500.NAT
- SLK.2000.NAT
- SLK.2500.NAT
- SLK.3000.NAT
- SLK.3500.NAT

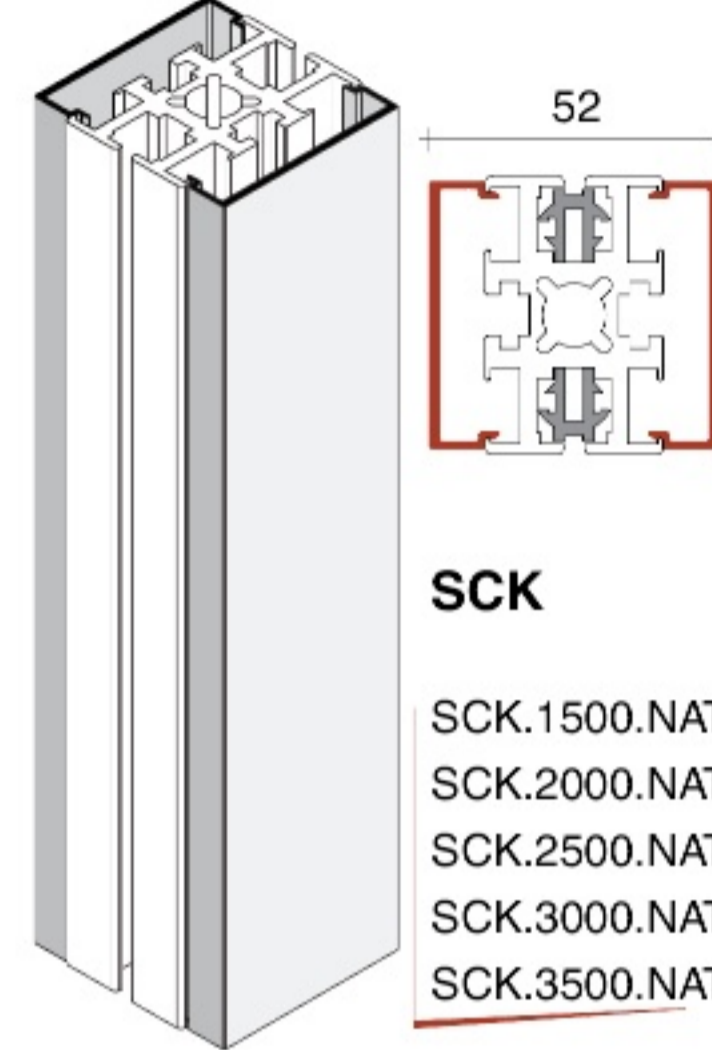

SCK

- SCK.1500.NAT
- SCK.2000.NAT
- SCK.2500.NAT
- SCK.3000.NAT
- SCK.3500.NAT

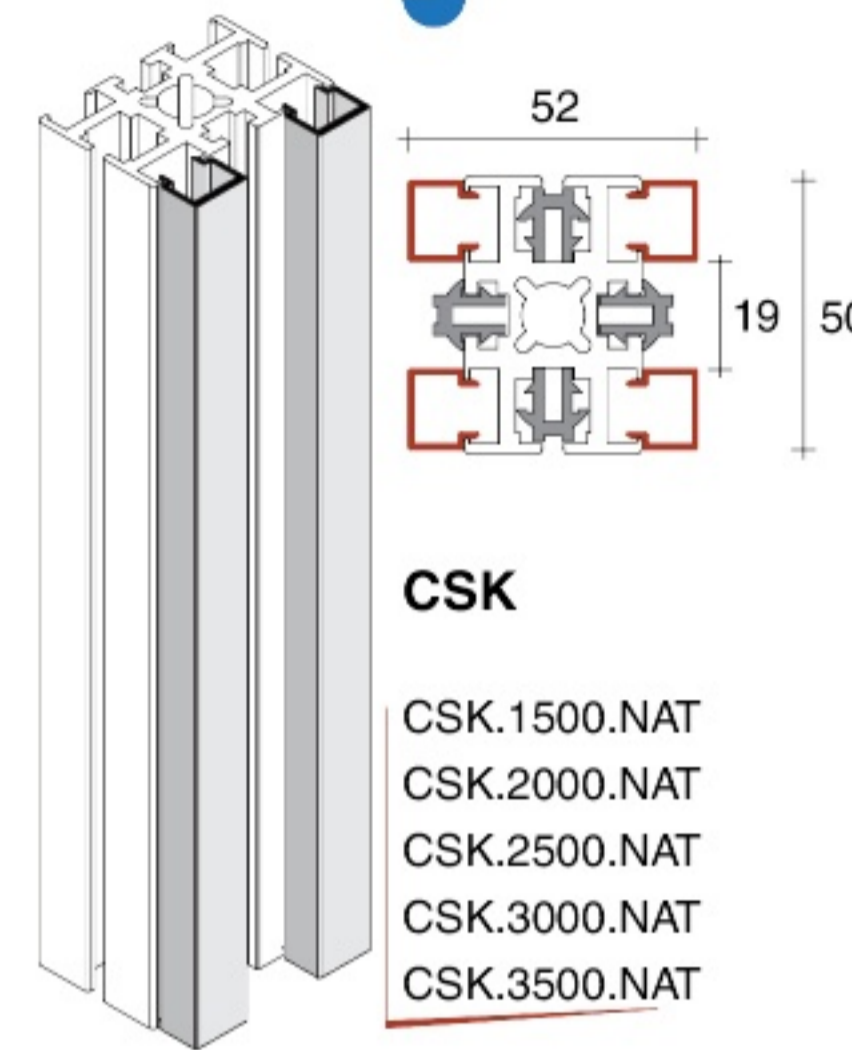

CSK

- CSK.1500.NAT
- CSK.2000.NAT
- CSK.2500.NAT
- CSK.3000.NAT
- CSK.3500.NAT

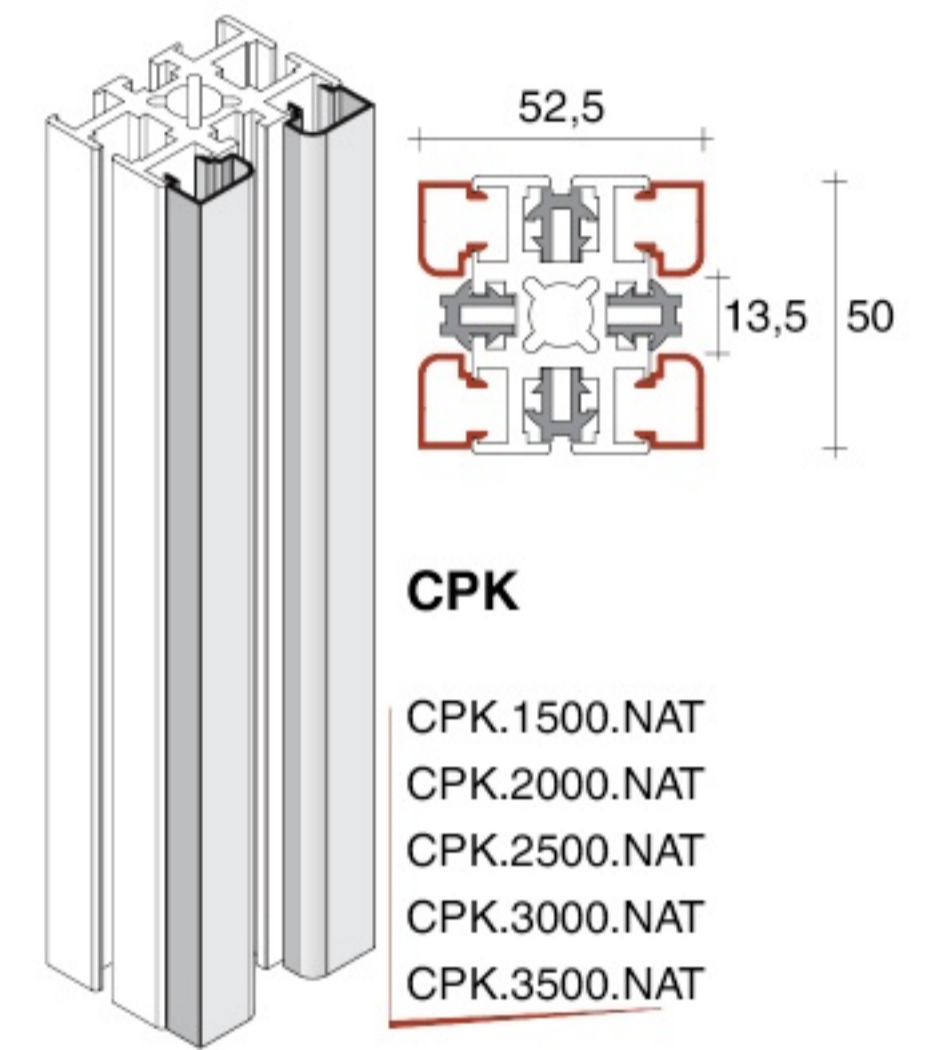

CPK

- CPK.1500.NAT
- CPK.2000.NAT
- CPK.2500.NAT
- CPK.3000.NAT
- CPK.3500.NAT

CREMAGLIERA SINGOLA AD INSERIMENTO

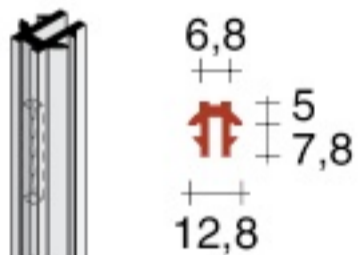

LMK

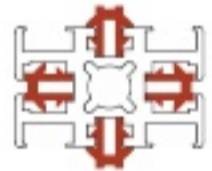

HLE

- HLE.2013.NAT
- HLE.2531.NAT
- HLE.3012.NAT

RMS / RMC / RDC



TK5

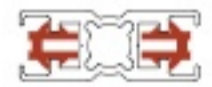

TR5



PIASTRE DI FISSAGGIO A MURO

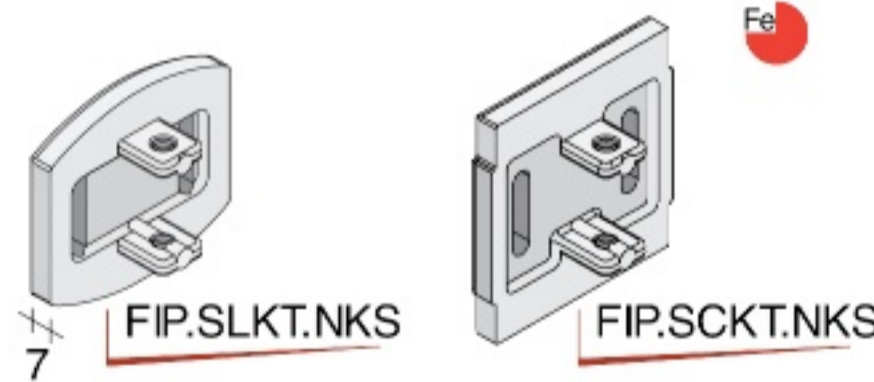

FIP.SLKT.NKS

FIP.SCKT.NKS

BASI FORATE

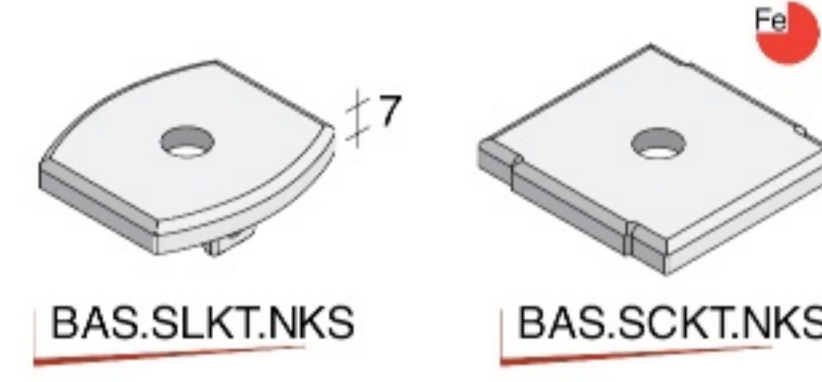

BAS.SLKT.NKS

BAS.SCKT.NKS

TAPPI DI FINITURA

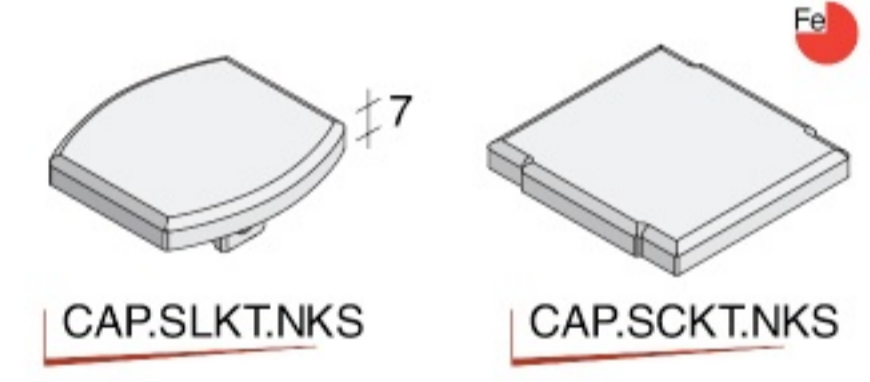

CAP.SLKT.NKS

CAP.SCKT.NKS

UTILIZZO CON PANNELLI

Tassello di montaggio pannelli ad incastro

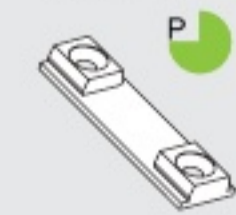

PKA.FPK1.TRA

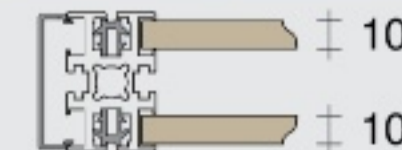
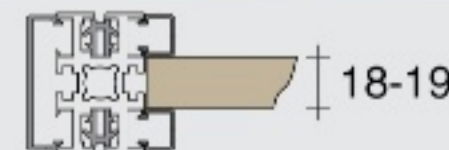
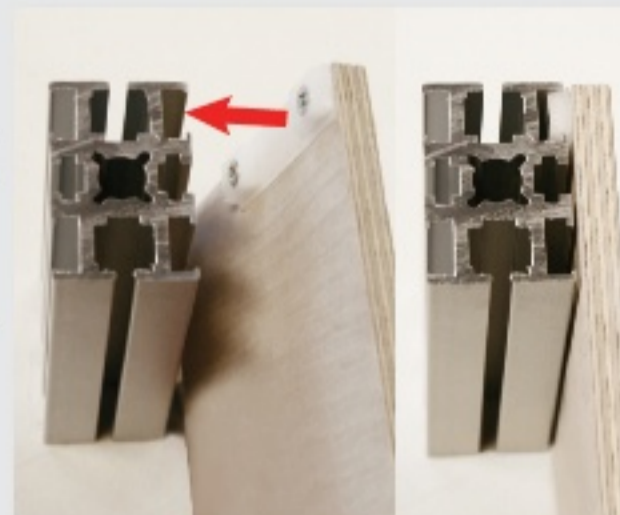

GIUNTO per raccordi a 90°

LMK - LMK

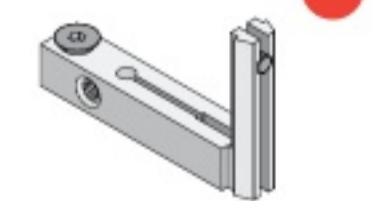

CAV.10M5.GRE





COMPOSIZIONI PAVIMENTO-PARETE con accessori CENTRALI su CREMAGLIERA





GONDOLE ATTREZZABILI con PANNELLI DIVISORI INTERNI

'ISOLA' - realizzata con LMK

